

Studies on Susceptibility to Bacterial Spot in Peach

A Dissertation Submitted to
the Graduate School of Life and Environmental Sciences,
the University of Tsukuba,
in Partial Fulfillment of the Requirements
for the Degree of Doctor of Philosophy in Agricultural Science
(Doctoral Program in Advanced Agricultural Technology and Sciences)

Yuko SUESADA

Contents

Summary	1
Abbreviations	
 <i>Chapter 1</i>	
General introduction	4
 <i>Chapter 2</i>	
Varietal differences in susceptibility to bacterial spot (<i>Xanthomonas arboricola</i> pv. <i>pruni</i>) among 69 peach cultivars and selections as evaluated by artificial inoculation of shoots	
Introduction	18
Materials and Methods	20
Results	23
Discussion	25
Tables and Figures	28
 <i>Chapter 3</i>	
Inheritance of susceptibility to bacterial spot in a population of offspring from crosses between Brazilian and Japanese cultivars/selections	
Introduction	42
Materials and Methods	44
Results	48
Discussion	51
Tables and Figures	56
 <i>Chapter 4</i>	
General discussion	73
Acknowledgements	82
References	83

Summary

The area of peach production in Japan has been moved because of disease occurrence and the development of a distribution transport network to the existing cultivation areas. The stability of peach production is being disrupted by climate change and frequent damage by pests and diseases that used not to be a problem. One such disease is peach bacterial spot caused by the bacterium *Xanthomonas arboricola* pv. *pruni*. The symptoms are defoliation and lesions on leaves, fruits, and branches. Defoliation in the early season reduces tree vigor, and lesions on fruits reduce their marketability. To avoid damage by bacterial spot, applications of chemical agents and cultural control by excision of diseased twigs are used. However, the effect of each measure is limited. Therefore, cultivars resistant to bacterial spot are needed, yet their breeding has not been promoted in Japan.

The purpose of this study was to find an efficient way to promote breeding for resistance to bacterial spot. I pursued the following aims: (1) to develop a method suitable for testing the resistance of multiple cultivars/selections; (2) to search for resistant breeding materials by evaluating genetic resources; and (3) to elucidate the manner of inheritance of resistance.

In this study, shoots were artificially inoculated, and lesion length was measured as an indicator of resistance. (1) Current shoots on trees in an orchard were slightly wounded and bacterial suspension was injected by a syringe with 10 26-gauge needles in June. Lesions were formed at all injection sites, and lesion length differed among cultivars/selections. Analysis of variance (ANOVA) revealed that the effect of cultivar/selection but not year was significant. Comparison of the inoculation time and concentration revealed that at Tsukuba, susceptibility was evaluated most reliably by inoculation of shoots at 10^8 cfu·mL⁻¹ in June. (2) Among 69 genetic resources, ‘Chimarrita’, a cultivar with a low chilling requirement

introduced from Brazil, 'Mochizuki', a cultivar used for processing, and 'Tsukikagami', a late-maturing table cultivar, were selected as relatively resistant. (3) The manner of inheritance was elucidated by analysis of data from a population of 514 offspring from 27 crosses—6 Brazilian crosses (at least one parent derived from 'Chimarrita' or 'Coral') and 21 Japanese ones—in the breeding program at the Institute of Fruit Tree and Tea Science, NARO (NIFTS). The mean lesion length log-transformed values (LLVs) of progeny from crosses between Brazilian cultivars/selections with low LLVs and cultivars/selections with high LLVs were low and close to the LLVs of the Brazilian parents. This result indicates the presence of a QTL related to bacterial spot resistance derived from 'Chimarrita' or 'Coral'. From crosses between Japanese cultivars/sections, offspring with low LLVs obtained was a few. It also indicates that offspring with low LLVs from crosses between Japanese cultivars/selections would be rare. This study shows that by using 'Chimarrita' or 'Coral' as a parent, cultivars combining resistance to bacterial spot and high fruit quality can be developed.

The information on varietal differences in susceptibility and inheritance of resistance might be useful in promoting breeding for resistance to bacterial spot.

Abbreviations

ANOVA	Analysis of variance
EPPO	European and Mediterranean Plant Protection Organization
LLV	Lesion length value
NGRC	Genetic Resources Center, NARO
NIFTS	Institute of Fruit Tree and Tea Science, NARO
QTLs	Quantitative trait loci

Chapter 1

General introduction

Peach (*Prunus persica* (L.) Batsch) belongs to the Amygdaloideae subfamily of the Rosaceae family. Among Amygdaloideae species, almond (*Prunus amygdalus* Lindl.), apricot (*Prunus armeniaca* L.), cherry (*Prunus avium* (L.) L.), European plum (*Prunus domestica* L.), Japanese apricot (*Prunus mume* Siebold & Zucc.), and Japanese plum (*Prunus salicina* Lindl.), known as stone fruits, are grown for table consumption. Peach originated in China and is grown worldwide (Byrne *et al.*, 2012).

According to the Food and Agriculture Organization of the United Nations (FAO), more than 50% of peach fruits were produced in China, followed by Spain, Italy, the USA, and Iran in 2016 (Table 1-1). Important traits include fruit shape, color, and hair presence. In Japan, clingstone peaches with white melting flesh are predominant, but other peaches (round or flat, with melting or non-melting flesh, white or yellow) are also grown worldwide.

In 2016, Japan ranked 19th in peach production, behind Mexico and Algeria (FAO, 2018). The area of peach production in Japan peaked around the 1970s and decreased remarkably in the mid-1980s and has been slowly decreasing in 2000s (Fig. 1-1), reaching about 10,000 ha in 2016. The main peach production areas are Yamanashi Prefecture (3500 ha), Fukushima Prefecture (1780 ha), and Nagano Prefecture (1150 ha) (Table 1-4). The major cultivars are ‘Akatsuki’ (18% of the total cultivation area), ‘Hakuhou’ (16%), ‘Kawanakajima Hakutou’ (13%), and ‘Hikawa Hakuhou’ (10%) (Fig. 1-2). ‘Akatsuki’ is derived from a cross between ‘Hakutou’ and ‘Hakuhou’, released by NIFTS. ‘Hakuhou’ is derived from a cross between ‘Hakutou’ and ‘Tachibana Wase’. ‘Kawanakajima Hakutou’ originated from a chance seedling found in Nagano.

Like other deciduous fruit trees, peach is prone to a number of diseases, notably bacterial spot (caused by *Xanthomonas arboricola* pv. *pruni*), brown rot (*Monilinia fructicola*) (Fig. 1-3a), anthracnose (*Colletotrichum acutatum*), and peach scab (*Cladosporium carpophilum*) (Fig. 1-3b). Some pathogens attack peach fruits and reduce their market value (Figs. 1-3a, 1-3b, 1-4a). Diseases caused by bacteria are more difficult to suppress than those caused by fungi. Bacterial diseases of stone fruits include bacterial spot of peach, bacterial canker of plum, bacterial shot hole, bacterial canker of apricot, and canker of Japanese apricot (Table 1-3). Peach bacterial spot (Figs. 1-4, 1-5a), bacterial canker of plum (Fig. 1-5b), and bacterial shot hole of apricot (Fig. 1-5c) are caused by *X. arboricola* pv. *pruni*. Bacterial canker of apricot and canker of Japanese apricot (Fig. 1-5d) are caused by *Pseudomonas syringae* pv. *morsprunorum*.

Bacterial spot is a serious peach disease around the world (OEPP/EPPO, 2006). Although *X. arboricola* pv. *pruni* is the main cause, the disease can also be caused by *P. syringae* pv. *syringae* van Hall and *Erwinia nigrifluens* Wilson, Star and Berger (Takanashi, 1985). The disease caused by *X. arboricola* pv. *pruni* was first reported by Smith (1903) as black spot of plum; peach bacterial spot and apricot bacterial spot are also caused by this pathogen (Takanashi, 1978). This bacterium is found in the following major peach production countries: Italy and Ukraine (Europe), China, India, Japan, North and South Korea, and Pakistan (Asia), South Africa (Africa), Argentina, Brazil, Mexico, and the USA (Americas), and Australia (Oceania) (EPPO, 2017, 2018).

Symptoms of peach bacterial spot are leaf lesions (Fig. 1-5a), branch lesions (Figs. 1-4d, e), fruit lesions (Figs. 1-4a, b), and defoliation (Fig. 1-4c). Disease spots on fruits reduce or eliminate their merchantability, causing economic damage. Intense defoliation in the early season reduces tree vigor and lowers productivity in the following year. In neglected peach orchards, 25%–75% of fruits may be attacked (Dunegan, 1932).

Disease occurrence can be reduced by keeping bacterial density low and by increasing plant resistance. Bacterial density can be reduced by spraying with agricultural chemicals and by removing branches with lesions in early spring. Although the combination of these two approaches has a preventive effect, its effectiveness is limited under weather conditions favorable for disease. Agricultural chemicals effective for peach bacterial spot control are antibiotics such as streptomycin, and inorganic copper agents such as Bordeaux mixture. However, the Japanese pesticide registration law limits spraying to 30–60 days before harvesting, and copper agents are toxic to peach leaves during the growing period. The number of chemicals that can be sprayed during fruit maturation is small, and it is difficult to satisfy the chemical application rotation to prevent an increase in drug-resistant bacteria. In addition, removing branches with lesions and taking them out of the orchard for several years is very labor consuming and has little immediate effect. The use of resistant cultivars thus offers an efficient way to reduce damage.

The first occurrence of bacterial spot in Japan was reported by Kuwatsuka (1919). Regular surveys are now conducted in the prefectures as part of the Ministry of Agriculture, Forestry and Fisheries (MAFF) Prevalence Reconnaissance Business (Plant Protection Act, 1950). In recent years, the frequency of warnings on peach bacterial spot issued by MAFF has been increasing, especially in Fukushima Prefecture, one of the main production areas (Table 1-2). In many prefectures, the disease is now widespread (Table 1-4). One possible reason is that climate change has promoted weather conditions favorable for disease occurrence. Another may be an increase in peach production at the disease favorable area. Conditions that favor bacterial spot occurrence are heavy rain, strong winds, and cool humid summers. Torrential rain and strong winds in early spring promote disease progression during the early stage. The decrease in rice production caused by a decrease in prices has increased conversion of paddy fields into peach orchards, which are often located near water sources

(rivers or waterways), which tend to create humid conditions favorable for peach bacterial spot in summer.

Several studies of varietal differences in susceptibility to peach bacterial spot have been conducted in Japan (Table 1-5). However, it is difficult to use the results because the target cultivars differed in each survey and most studies evaluated cultivated orchards, so the results were greatly affected by climate conditions and bacterial density.

The objectives of this study were (1) to develop a method suitable for testing the resistance of multiple cultivars/selections (2) to evaluate the susceptibility of peach cultivars/selections to bacterial spot with high reliability by an artificial inoculation method, and (3) to elucidate the manner of inheritance of susceptibility. This study will promote breeding for resistance to peach bacterial spot.

Table 1-1. Ranking of countries according to peach and nectarine production based on statistics published by FAO (2016).

Rank	Country	Production (thousand tonnes)
1	China	14441
2	Spain	1530
3	Italy	1428
4	USA	927
5	Iran	864
6	Greece	848
7	Turkey	674
8	Chile	337
9	India	288
10	Egypt	267
11	Argentina	248
12	South Korea	230
13	Uzbekistan	226
14	France	208
15	Brazil	192
16	South Africa	180
17	Mexico	177
18	Algeria	169
19	Japan	127
20	Tunisia	123
Total		24976

<http://www.fao.org/faostat/en/#data/QC>

Table 1-2. Disease occurrence warnings for peach bacterial spot issued by MAFF (2003–2018).

Year	Announced Prefecture	Date of issuance
2003	Wakayama	May-18
2004	Kagawa	May-18
2005	Okayama	May-18
	Gifu	June-18
2006	Fukushima	May-18
2007	Fukushima	May-18
	Fukushima	September-18
2008	Fukushima	May-08
2009	Niigata	August-18
2010	Fukushima	June-18
	Fukushima	September-18
2011	Fukushima	June-18
	Nagano	June-18
	Osaka	June-18
	Niigata	August-18
2012	Fukushima	May-18
	Fukushima	August-18
2013	Fukushima	May-18
	Wakayama	May-18
2014	Fukushima	May-18
	Fukushima	August-18
2015	Fukushima	April-18
	Fukushima	May-18
2016	Fukushima	April-18
	Aichi	May-18
	Okayama	June-18
	Osaka	July-18
	Wakayama	August-18
2017		
2018	Wakayama	April-18
	Okayama	April-18
	Fukushima	April-18
	Kagawa	May-18
	Nagano	May-18
	Niigata	May-18
	Wakayama	May-18
	Okayama	May-18
	Fukushima	May-18

http://www.maff.go.jp/j/syouan/syokubo/boujyo/120104_yoho.html

Table 1-3. Bacterial diseases of stone fruits.

Crop	Disease	Causal bacteria
Peach	Bacterial spot	<i>Xanthomonas arboricola</i> pv. <i>pruni</i>
		<i>Pseudomonas syringae</i> pv. <i>syringae</i>
		<i>Erwinia nigrifluens</i>
Plum	Bacterial canker	<i>Xanthomonas arboricola</i> pv. <i>pruni</i>
Apricot	Bacterial shot hole	<i>Xanthomonas arboricola</i> pv. <i>pruni</i>
	Bacterial canker	<i>Pseudomonas syringae</i> pv. <i>morsprunorum</i>
Japanese apricot	Canker	<i>Pseudomonas syringae</i> pv. <i>morsprunorum</i>

Table 1-4. Main peach production areas, bacterial spot occurrence areas, and their ratios in Japan (2014) based on statistics published by MAFF (2018).

Prefecture	Cultivated area (ha)	Occurrence area (ha)	Rate of occurrence (%)
Yamanashi	3500	140	4
Fukushima	1780	1391	78
Nagano	1150	404	35
Wakayama	777	466	60
Okayama	674	85	13
Yamagata	647	140	22
Niigata	234	220	94
Kagawa	218	218	100
Aichi	214	161	75
Aomori	112	61	54
Akita	101	53	52
Gifu	88	24	27
Tokushima	51	51	100
Osaka	44	15	34
Toyama	29	15	52
Total	9619		

http://www.maff.go.jp/j/syouan/syokubo/gaichu/syokubo_nenpo.html

Table 1-5. Reported varietal differences in susceptibility to bacterial spot revealed by orchard evaluation in Japan.

Resistant cultivars	Susceptible cultivars	Year	Location	Reference
Fuji, Shogyoku	Hakuhou, Showa, Okubo, Yamato Hakutou, Okayama 500, Koyo Hakutou, Reikou	1953	Kanagawa Pref.	Yamamoto, Y. <i>et al.</i> ^z
Nishiki, Okitsu	Sunago Wase, Okubo, Hakuhou	1966	Yamagata Pref.	Shima, T. <i>et al.</i> ^y
Red Haven, Chugoku Yaseitou	Hakuhou, Hakutou, Koyo Hakutou, Matsumori Wase, Nishino Hakutou, Okayama Wase, Sunago Wase etc.	1978	Kanagawa Pref.	Takanashi, K. ^x

^zYamamoto, Y., C. Ogaki and Y. Tatsuno. 1953. Experiments and investigations on the bacterial spot of peach. 1) Effects of weather condition on outbreak of the disease, and susceptibility in the varieties of peach.

^yShima, T., T. Shoji and S. Suzuki. 1966. Studies on the resistance of peach varieties to the infection of bacterial spot, *Xanthomonas pruni* (E. F. Smith) Dowson, in the sand hill of Shonai district.

^xTakanashi, K. 1978. Ecological studies on bacterial spot caused by *Xanthomonas pruni* (E. F. Smith) Dowson.

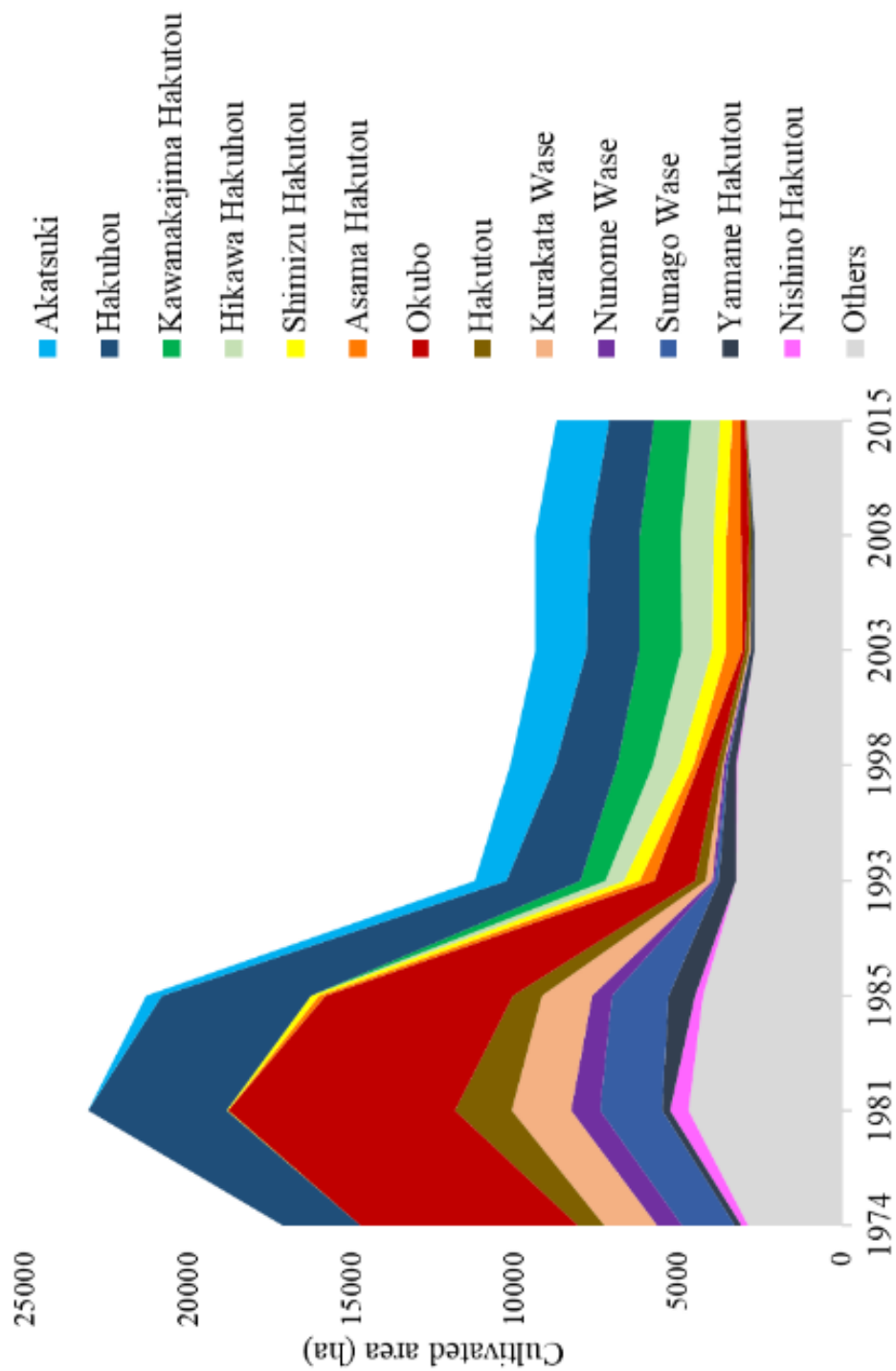

Fig. 1-1. Chronological changes in varietal shares of peach production in Japan (1974–2015) based on statistics published by MAFF.

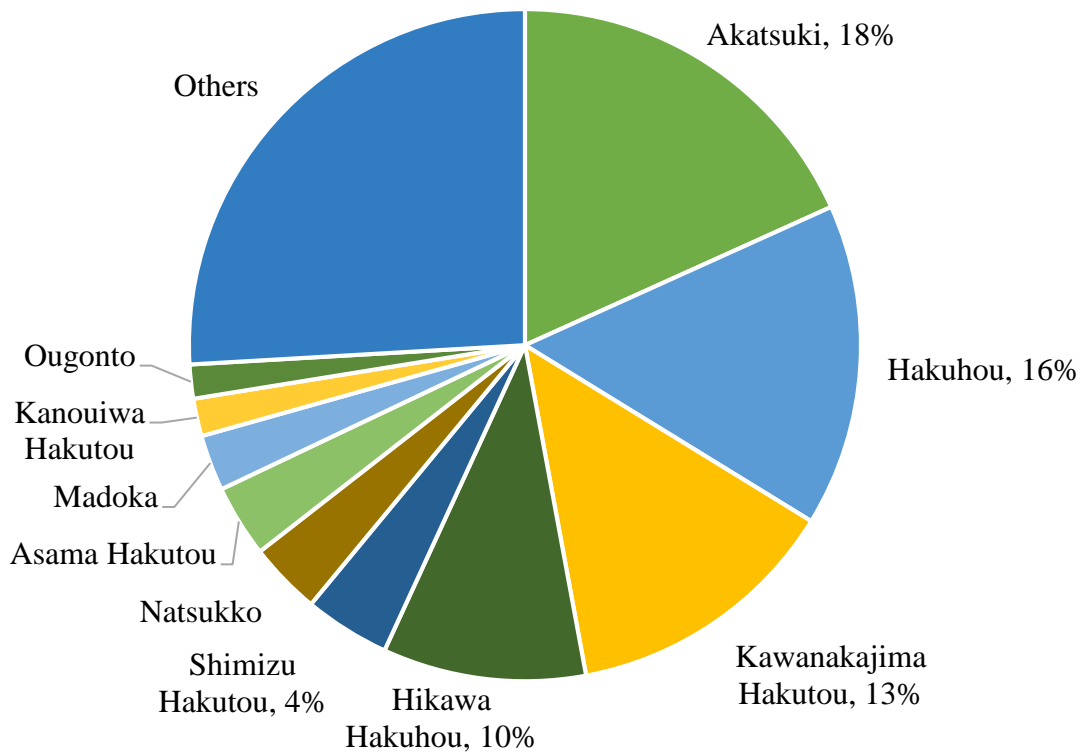

Fig. 1-2. Varietal shares of peach production in Japan (2015) based on statistics published by MAFF (2018).

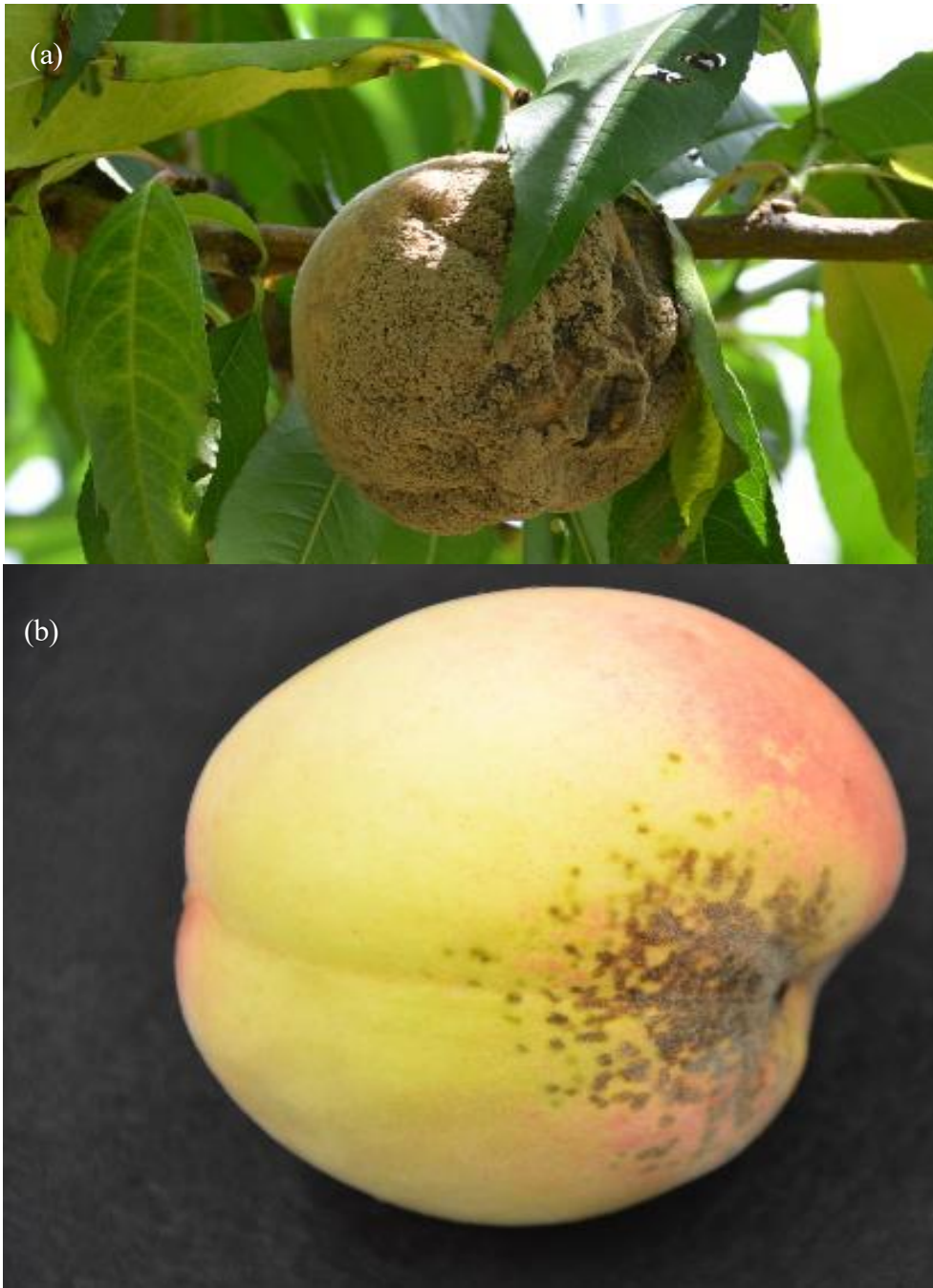

Fig. 1-3. Peach fruits damaged by diseases. (a) Brown rot caused by *Monilinia fructicola*; (b) Scab caused by *Cladosporium carpophilum*. (Photographed by NIFTS)



Fig. 1-4. Symptoms of peach bacterial spot caused by *Xanthomonas arboricola* pv. *pruni*.

(a) Mature fruit; (b) young fruit; (c) seriously defoliated tree in October; (d) shoot with spring canker; (e) shoot with summer canker. (Photographed by NIFTS)

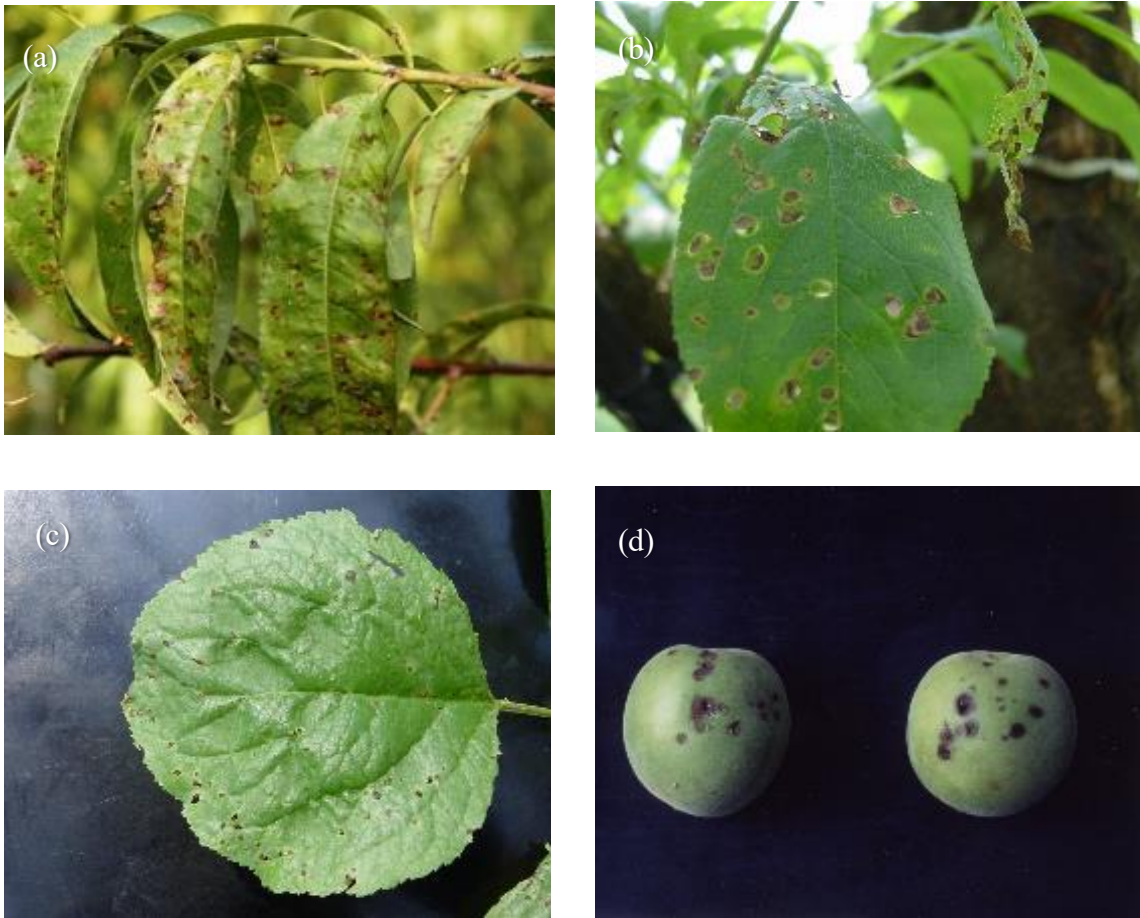

Fig. 1-5. Symptoms of bacterial diseases of stone fruits. (a) Leaf symptom peach caused by *Xanthomonas arboricola* pv. *pruni*; (b) leaf symptom of Japanese plum by *X. arboricola* pv. *pruni*; (c) leaf symptom of apricot (*Prunus armeniaca*) by *X. arboricola* pv. *pruni*; (d) fruit symptom of Japanese apricot by *Pseudomonas syringae* pv. *morsprunorum*. (Photographed by NIFTS)

Chapter 2

Varietal differences in susceptibility to bacterial spot (*Xanthomonas arboricola* pv. *pruni*) among 69 peach cultivars and selections as evaluated by artificial inoculation of shoots

Introduction

Bacterial spot caused by *X. arboricola* pv. *pruni* is one of the most important and serious diseases of peaches grown in windy and rainy areas. This microbe also attacks other stone-fruit crops such as Japanese plum, apricot and other *Prunus* spp. (Du Plessis, 1988; Kuwatsuka, 1921; Werner *et al.*, 1986). The symptoms of the disease are defoliation and spots on the leaves, twigs, and fruit. Leaf spots and severe defoliation damage growing trees, and spots on the fruit reduce commercial value of the peaches. Since complete control by chemical application is difficult, it is considered that the use of resistant cultivars is the most effective way to control this disease. However, immune cultivars to bacterial spot are not known or used in Japan.

The susceptibility of cultivars to bacterial spot was evaluated and varietal differences were reported in other areas where stone fruits are grown, by Du Plessis (1988), Keil and Fogle (1974), Martins and Raseira (1996), Medeiros *et al.* (2011), Randhawa and Civerolo (1985), Sherman and Lyrene (1981), and Werner *et al.* (1986). Orchard susceptibility of economically important cultivars has been examined several times in Japan, and Yamamoto *et al.* (1953), Kuraoka and Kato (1955), Shiina *et al.* (1966), and Takanashi (1978) reported relatively resistant cultivars. However, the cultivation area of those cultivars has not increased. Furthermore, it was not easy with little chance for success to breed disease resistant cultivars, because the major objective of the recent breeding program was to improve fruit eating

quality. That is to say, bacterial spot disease resistance has not been a top priority in peach breeding program. In recent times, the commercially cultivated varieties have changed, and most currently grown cultivars have not been evaluated for their susceptibility to bacterial spot. Therefore, it is necessary to evaluate the resistance/susceptibility of peach cultivars and selections in peach breeding program.

Since it is difficult for evaluation under field conditions, frequently affected by climatic conditions and the density of the causal bacteria, it is advisable to evaluate trees using artificial inoculation. Topp *et al.* (1991) compared rating methods, including measurements of the number, size and incidence of leaf spots, percentage affected leaf area and stem canker spot length, and concluded that measuring the length of stem cankers at the injection sites was a simple and reproducible method. Miyake *et al.* (1999) improved the artificial inoculation method using multiple needles on shoots and reported varietal differences in the resistance of Japanese plum, apricot, and peach cultivars to bacterial spot.

Bacterial spot causes spring canker as well as summer canker on peach shoots. Spring canker is the main source of primary infection, and summer canker is a secondary cause (Takanashi, 1978). Infection occurs during autumn of the previous year and the overwintered lesion becomes a source of a spring canker, and it takes a longer time for spring canker from infection to lesion formation than summer canker. Furthermore, spring canker may be affected by the environmental factors. Since summer canker is easier to measure, this study focused on measuring summer canker after shoot inoculation.

Therefore, in this study, the varietal differences in shoots for bacterial spot disease were evaluated using the artificial inoculation method with multiple needles on shoots in peach genetic resources consisting of peach cultivars in commercial production in Japan and selections from the NIFTS peach breeding program. The effects were also evaluated for different times of inoculation and concentrations of inoculum on the lesion length.

Materials and Methods

Plant materials

Sixty-nine peach cultivars/selections from the genetic resources including cultivars in commercial production and breeding selections grown as independent trees at NIFTS (Tsukuba, Ibaraki, Japan) were used (Table 2-1). Tree ages of these plant materials ranged from 3 to 14 years old.

Inoculum

Xanthomonas arboricola pv. *pruni* (MAFF301420) was used as inoculate, supplied by the Genetic Resources Center, NARO (NGRC, formerly the National Institute of Agrobiological Sciences). Bacteria growing on potato dextrose agar were suspended in sterile water and adjusted to two different concentrations of 10^8 cfu·mL⁻¹ and 10^6 cfu·mL⁻¹.

Inoculation methods

A 5.0- mL syringe (Terumo, Tokyo) with ten 26-gauge needles (Terumo, Tokyo) was used to injure and inject the bacterial suspension at each site. Several current shoots, 30–40 cm long with basal diameters of about 5 mm were artificially inoculated on trees growing in the field (Fig. 2-1). Three points at intervals of 7 cm per shoot, three shoots per treatment were lightly wounded by pricking the shoot surface with needles and injected with the bacterial suspension using multiple needles. Current shoots were chosen in June and were subjected to multiple-needle injection of the bacterial suspension at a concentration of 10^8 cfu·mL⁻¹. Inoculated shoots were collected, lesion lengths were measured in late August or early September and the average length (X) was calculated for each shoot.

Experiment 1 -yearly effect and the genotype x year interaction for lesion length -

Twenty-five peach cultivars listed in Table 2-1 were tested repeatedly for three years from 2006 to 2008. Current shoots of nine cultivars ('Akatsuki', 'Chiyohime', 'Harrow Beauty', 'Manami', 'Masahime', 'Mochizuki', 'Natsuotome', 'Nishiki' and 'Shimizu Hakutou') were wounded and injected with sterile water as the control in the same way as the artificially inoculated shoots in 2006. The average lesion length was 5.5 mm for the nine cultivars. Therefore, the value of $(X - 5.5)$ was used as the value showing the effect of the bacterial inoculation. In addition, as the average and standard deviation were correlated, $\log_{10}(X - 5.5)$ were used for statistical analysis (the shoot measured value). The average value of $\log_{10}(X - 5.5)$ for the three shoots from each genotype (cultivar/selection and offspring) per year was used as the LLV and was subjected to ANOVA. The model adopted here to express the measurement value is shown below:

$$P_{ijk} = \mu + g_{1i} + y_j + (gy)_{ij} + e_{1ijk}$$

where P_{ijk} is the k th shoot measured value of the i th genotype of the j th year; μ is a constant value (the overall mean); g_{1i} is the random effect contributed by the i th genotype; y_j is the random effect contributed by the j th year; $(gy)_{ij}$ is the interaction between the i th genotype and the j th year; e_{1ijk} is the error in the k th shoot of the i th genotype in the j th year.

Distribution of the error estimate, which was obtained as the deviation of each shoot measured value from the average shoot measured value in a cultivar and year, approached normal distribution with the Kolmogorov-Smirnov one-sample test at ($P = 0.05$) (Campbell, 1974).

Experiment 2 - varietal differences in disease resistance to peach bacterial spot -

Sixty-nine peach cultivars/selections were tested (Table 2-1), consisting of 57 table peach cultivars/selections, which had been grown or are presently grown commercially in Japan and selections tested for future commercial production, six canning peach cultivars/selections, and six peach cultivars introduced from foreign countries. Every cultivar/selection was tested for two years from 2006 to 2008 in the same way as described in *the Experiment 1*. The value of $(X - 5.5)$ was used as the value showing the effect of the bacterial inoculation, and $\log_{10}(X - 5.5)$ was calculated as the shoot measured value.

Experiment 3 -effect of different times of inoculation and concentrations of inoculum on lesion length-

Six cultivars/selections ('Akatsuki', 'Kawanakajima Hakutou', 'Mochizuki', Momo Tsukuba 130, 'Nakatsu Hakutou' and 'Yuzora') were used. Six current shoots per cultivar/selection were chosen at three times (May, June, July), and three current shoots per cultivar/selection and three sites per shoot were wounded by multiple-needle injections with the bacterial suspension of 10^6 cfu·mL⁻¹ or 10^8 cfu·mL⁻¹ in 2009. Inoculated shoots were collected, and the average lesion length (mm) on each shoot (X) was measured in late August. The value of $(X - 5.5)$ was used as the value showing the effect of the bacterial inoculation as in *Experiments 1 and 2*, and $\log_{10}(X - 5.5)$ was calculated as the shoot measured value.

The three shoot measured values for each cultivar (genotype) and treatment were subjected to ANOVA. The model adopted here to express the phenotypic value is shown below:

$$P_{ijkl} = \mu + g_{2i} + t_j + c_k + (gt)_{ij} + (gc)_{ik} + (tc)_{jk} + (gtc)_{ijk} + e_{2ijkl}$$

where P_{ijkl} is the l th shoot measured value of the i th genotype of the j th time in the k th concentration; μ is a constant value (the overall mean); g_{2i} is the fixed effect contributed to by the i th genotype; t_j is the fixed effect contributed to by the j th time; c_k is the fixed effect

contributed to by the k th concentration, $(gt)_{ij}$ is the interaction between the i th genotype and the j th time; $(gc)_{ik}$ is the interaction between the i th genotype and the k th concentration; $(tc)_{jk}$ is the interaction between the j th time and the k th concentration; $(gtc)_{ijk}$ is the interaction among the i th genotype, the j th time and the k th concentration; e_{2ijkl} is the error in the l th shoot of the i th genotype of the j th time at the k th concentration.

Distribution of the error estimate, which was obtained as the deviation of each shoot measured value from the average shoot measured value in a cultivar, time and concentration, approached normal distribution with the Kolmogorov-Smirnov one-sample test at ($P = 0.05$) (Campbell, 1974).

Results

Experiment 1 - yearly effect and the genotype x year interaction for lesion length -

The result of ANOVA showed that the effect of genotype was significant ($P < 0.01$), and the effect of year was not significant ($P > 0.05$) (Table 2-2). The interaction between the cultivar and the year was significant at ($P < 0.01$) (Table 2-2). The variance components of cultivar (σ_g^2), year (σ_y^2), the cultivar \times year interaction (σ_{gy}^2), and error (σ^2), were estimated as 0.045, 0, 0.016, and 0.058, respectively (Table 2-3).

Experiment 2 - varietal differences in disease resistance to peach bacterial spot -

Bacterial spot lesions on some cultivars after inoculation are shown in Fig. 2-2. All cultivars/selections had longer lesions than the control. The LLVs are presented in Fig. 2-3, for the 69 peach cultivars/selections artificially inoculated with bacterial suspension. The log-transformed lesion lengths ranged from 0.476 for ‘Chimarrita’ to 1.606 for ‘Nakatsu Hakutou’. Comparing white-fleshed cultivars/selections and yellow-fleshed

cultivars/selections, no relationship would be observed between flesh color and lesion length. The mean of LLVs of 57 table peach cultivars/selections in Japan was 1.090, showing nearly the same value as that of an ancestral cultivar ‘Shanghai Suimitao’ (1.045). From a chronological perspective, the LLVs of old cultivars seemed to be similar to those of new cultivars.

Using the error variance (σ_{e1}^2) in *Experiment 1*, SE and $LSD_{0.05}$ were calculated. Each cultivar/selection value calculated as the average value for two years had an error variance (σ_E^2) of $\{(\sigma_{gy}^2 + \sigma_{e1}^2 / 3)\} / 2 = 0.018$ and SE of 0.132. $LSD_{0.05}$ was calculated as 0.367. The phenotypic variance for cultivar/selection (σ_P^2), which was the variance among the cultivar/selection values, was estimated as 0.061. The genetic variance (σ_G^2) in the whole population was estimated as $\sigma_P^2 - \sigma_E^2$, and 0.043. Broad-sense heritability, defined as σ_G^2 / σ_P^2 , was 0.71. The genetic variances were estimated as 0.030, 0.090, and 0.074 for 57 Japanese table peach cultivars/selections, six canning cultivars, and six foreign cultivars, respectively.

Experiment 3- effect of different times of inoculation and concentrations of inoculum on lesion length -

All the effects of the factors and their interactions were highly significant ($P < 0.01$) except for the effect of the inoculation time (Table 2-5). The estimates shown as κ^2 in Table 2-5 were used as indicators showing the extent of the effect or interaction, and the percentages of each κ^2 or the error variance σ_{e2}^2 to the sum of seven κ^2 s and σ_{e2}^2 were calculated in Table 2-6. The percentage for cultivar was the largest as 44.0%, followed by that for the cultivar \times time interaction (14.3%), the inoculum concentration (13.7%), and the cultivar \times concentration interaction (12.8%). The percentage was 6.8% for the cultivar \times time \times concentration interaction, 6.7% for the error, and 0.3% for the inoculation time.

While the lesion lengths of ‘Kawanakajima Hakutou’ and ‘Nakatsu Hakutou’ were the largest in May and the smallest in July, those of ‘Akatsuki’ and ‘Yuzora’ were the large in July and the small in May (Table 2-4). The cultivar × time interaction was significant ($P < 0.01$) (Table 2-5).

Average lesion lengths were 16.3 mm and 19.5 mm for inocula of 10^6 cfu·mL⁻¹ and 10^8 cfu·mL⁻¹, respectively (Table 2-4), and the effect of the inoculum concentration was highly significant (Table 2-5). The effect was significant, meaning that cultivar performance shifted in parallel depending on the inoculum concentration.

Discussion

The result of ANOVA for cultivar/selection and year in the *Experiment 1* showed that the effect of the genotype was significant and the effect of the year was not. No significance of the effect of the year in the *Experiment 1* mean that yearly environmental conditions have little effect on LLVs. The condition of peach trees may be stable, irrespective of the year tested. The data from different test years can be directly combined and compared.

Different inoculation times and inoculum concentrations were tried to determine suitable conditions for conducting the inoculation test. Current shoots of suitable size (30–40 cm long, and 5 mm basal diameter) for artificial inoculation were not available in sufficient quantity at NIFTS in May and July. Considerably short shoots were obtained in May and rather long and thick shoots were obtained in July. Because of the larger lesion length of the high-susceptible cultivar (‘Kawanakajima Hakutou’ and ‘Nakatsu Hakutou’) in the early season inoculation, it is easy to distinguish from resistant varieties at early inoculation time. Since it was easy to obtain appropriate shoots in June, comparison with May and July, June could be the best time to inoculate shoots at this location. Although the effect of time was not

significant, cultivar \times time interaction was significant ($P < 0.01$). This result may be contributed to by 'Kawanakajima Hakutou', whose LLVs were notably larger in May than in June and July. Among the 69 cultivars/selections tested, there was no completely immune cultivar. However, there were varietal differences in susceptibility to bacterial spot. Japanese peach breeding program has been carried out emphasizing on fruit quality within a small gene pool of genetic resources derived from 'Shanghai Suimitao' in Japan (Yamamoto *et al.*, 2003). Japanese table peach cultivars/selections had small genetic variance in their resistance to bacterial spot. Compared with the value of 'Shanghai Suimitao', two cultivars ('Benishimizu' and 'Tsukikagami') were found with significantly lower values and six cultivars ('Asama Hakutou', 'Kiyomi', 'Kurakatawase', 'Nakatsu Hakutou', 'Shizuku Red', and 'Sweet Nectarine Reimei') showed significantly higher values, based on the LSD. On the other hand, 'Chimaritta' and 'Harson' from the six foreign cultivars and 'Mochizuki' and 'Nishiki' from the six canning cultivars/selections had significantly lower values, which showed significant resistance to bacterial spot.

It was pointed out that cultivars developed in areas where bacterial spot is a serious problem generally show more resistance than other cultivars selected in regions with less frequent occurrence of the disease (Keil and Fogle, 1974; Topp and Sherman, 1995; Werner *et al.*, 1986). Therefore, cultivars developed in areas prone to bacterial spot were compared with those developed in areas with infrequent occurrence of bacterial spot. In Japan, Kanagawa, Aichi, and Nara Prefectures have sustained the most serious damage from bacterial spot, whereas Yamanashi, Fukushima, and Okayama Prefectures have rarely reported the occurrence of the disease (Takanashi, 1980). The five cultivars selected in Kanagawa, Aichi, and Nara Prefectures, consisting of 'Denjuro', 'Hakuhou', 'Nakatsu Hakutou', 'Nunome Wase', and 'Tachibana Wase' had a mean value of 1.197, whereas the 21 cultivars released from Yamanashi, Fukushima, and Okayama Prefectures, including

‘Doyo’, ‘Hakutou’, ‘Koyo Hakutou’, ‘Ookubo’, ‘Rikaku’, and ‘Shimizu Hakutou’, had a mean value of 1.069 (Table 2-1, Fig. 2-3). The relationship between the original area of the cultivar and resistance was not clear. In addition, susceptibility did not seem to change chronologically (Table 2-1, Fig. 2-3), suggesting the lack of bacterial spot resistance selection in Japanese peach breeding program.

The tested cultivars/selections included four siblings: ‘Sweet Nectarine Reimei’ (LLV; 1.424) vs. ‘Sweet Nectarine Shoko’ (1.006), ‘Masahime’ (0.771) vs. ‘Yoshihime’ (1.235), ‘Hatsuotome’ (0.993) vs. ‘Fukuotome’ (1.020), ‘Tsukuba 119’ (1.194) vs. ‘Tsukuba 120’ (1.172). LLVs were similar for two sibling pairs, ‘Hatsuotome’ vs. ‘Fukuotome’ and ‘Tsukuba 119’ vs. ‘Tsukuba 120’, however LLVs were not similar in the other sibling pairs. The inheritance of resistance to bacterial spot should be elucidated by a crossing experiment.

In this study, a Brazilian low-chilling requirement cultivar ‘Chimarrita’ (LLV; 0.476) (Fig. 2-4), a Canadian cultivar ‘Harson’ (0.504), ‘Mochizuki’ (0.514), and ‘Nishiki’ (0.522) had low LLVs and showed relatively resistance to bacterial spot. ‘Chimarrita’ does not have enough fruit quality for commercial production in Japanese climate conditions. ‘Nishiki’ and ‘Mochizuki’ (Fig. 2-5) are canning peach cultivars (Kajiura *et al.*, 1966; Yamaguchi *et al.*, 2001) and have non-melting flesh, unlike most table peach cultivars in Japan.

Based on phenotypic values for bacterial spot resistance, non-table peach cultivars such as ‘Nishiki’ and ‘Mochizuki’ (canning peaches), and ‘Harson’ and ‘Chimarrita’ (foreign cultivars), should be cross-parent candidates for the initial crosses. In addition, Japanese table peach cultivars/selections with high eating quality should be used as cross-parents with the aim of combining the resistance to bacterial spot with fruit quality in peach breeding program. Notably, ‘Tsukikagami’, a table peach cultivar, was relatively resistant and may be useful genetic material to breed combining high fruit quality and resistance to bacterial spot.

Table 2-1. Peach cultivars/selections used in the present study.

Cultivar/selection	Exp.1	Exp.2	Exp.3	Pedigree	Year of cultivar registration or appearing in commercial or test production ^z	Origin
Table peach cultivar/selection						
Abe Hakutou	○	○		Chance seedling	1985	Hiroshima
Akatsuki		○	○	Hakutou × Hakuhou	1979	NIFTS
Akizora	○	○		Nishino Hakutou × Akatsuki	1995	NIFTS
Asama Hakutou	○	○		Koyo Hakutou bud mutation	-	Yamanashi
Benikumimi	○	○		Akatsuki × Akatsuki	1992	Fukushima
Benishimizu	○	○		Chance seedling	1983	Okayama
Chiyohime	○	○		Koyo Hakutou × Saotome	1988	NIFTS
Chiyonaru	○	○		Momo Tsukuba 100 × Nunome Wase O.P. ^y -2	1989	NIFTS
Denjuro	○	○			1898	Kanagawa
Doyo	○	○		Chance seedling	1897	Okayama
Fukuotome	○	○		Kurakata Wase × Chiyohime	2003	Fukushima
Gyosei	○	○		Bud mutation of 'Akatsuki'	1986	Fukushima
Hakuhou	○	○		Hakutou × Tachibana Wase	1933	Kaganawa
Hakushu	○	○		U-9 × C2R19T182	2004	NIFTS
Hakutou	○	○		Chance seedling	1899	Okayama
Hatsuotome	○	○		Kurakata Wase × Chiyohime	2003	Fukushima
Hikawa Hakuhou	○	○		Bud mutation of 'Hakuhou'	1981	Yamanashi
Himekonatsu	○	○		182-3 O.P.	2009	NIFTS
Hinanotaki	○	○		G-62-8 × G-62-8	2010	NIFTS

^z: - indicates that the year of cultivar registration or release is uncertain, or unreleased selection.

^y: O. P. indicates open pollinated seedling.

Table 2-1. Continued.

Cultivar/selection	Exp.1	Exp.2	Exp.3	Pedigree	Year of cultivar registration or appearing in commercial or test production ^z	Origin
Ikeda (Nagano)		○			-	Nagano
Kanouiwa Hakutou	○	○		Bud mutation of 'Asama Hakutou'	1983	Yamanashi
Kawanakajima Hakutou	○	○	○	Chance seedling	-	Nagano
Kiyomi		○		Kinto × Early Crawford	-	Shizuoka
Koyo Hakutou		○		Chance seedling	1927	Okayama
Kurakata Wase		○			1951	Tokyo
Masahime	○	○		21-18 × Akatsuki	1993	NIFTS
Nagasaki Hakutou		○		Bud mutation of 'Hakuhou'	1985	Yamanashi
Nakatsu Hakutou		○	○	Hakutou O.P.	1955	Nara
Natsuki		○		Kawanakajima Hakutou × Chiyohime	1999	Nagano
Natsukko		○		Kawanakajima Hakutou × Akatsuki	2000	Nagano
Natsuotome	○	○		Akatsuki × Yoshihime	2002	NIFTS
Nishio Gold		○		Bud mutation of 'Golden Peach'	1988	Okayama
Nunome Wase		○		Chance seedling	1951	Aichi
Odoroki		○		Bud mutation of 'Hakuhou'	1991	Nagano
Ogonto	○	○		Chance seedling	-	Nagano
Okubo		○		Chance seedling in Hakutou Orchard	-	Okayama
Reiho		○		Bud mutation of 'Akatsuki'	-	Yamanashi
Rikaku		○		Shanghai Suimitao O.P.	1900	Okayama

Table 2-1. Continued.

Cultivar/selection	Exp.1	Exp.2	Exp.3	Pedigree	Year of cultivar registration or appearing in commercial or test production ^z	Origin
Sanekoubai		○		Local variety	-	Aomori
Saotome	○	○		Hakuhou × Robin	1983	NIFTS
Shanghai Suimitao		○			-	China
Shimizu Hakutou	○	○		Chance seedling in Hakutou and Okayama 3 orchard	-	Okayama
Shizuku Red		○		19-1 O.P.	1993	NIFTS
Sunago Wase		○		Chance seedling	1958	Okayama
Sweet Nectarine Reimei	○	○		Sotta Nectarine × Independence	1984	Yamanashi
Sweet Nectarine Shoko		○		Sotta Nectarine × Independence	1984	Yamanashi
Tachibana Wase		○		Denjuro O.P.	1910	Kanagawa
Takei Hakuhou	○	○		Chance seedling in Hakuhou orchard	-	Yamanashi
Tianjin Suimitao		○			-	China
Tsukiakari	○	○		Masahime × Akatsuki	2010	NIFTS
Tsukikagami		○		Momo Tsukuba 115 × Momo Tsukuba 105	2011	NIFTS
Tsukuba 119	○	○		Momo Tsukuba 116 × 203-1	-	NIFTS
Tsukuba 120	○	○		Momo Tsukuba 116 × 203-1	-	NIFTS
Tsukuba 122		○		Sunglo × 135-37	-	NIFTS
Tsukuba 124	○	○		Kawanakajima Hakutou × 252-4	-	NIFTS
Tsukuba 130			○	Mochizuki × Hakushu	-	NIFTS
Yoshihime	○	○		21-18 × Akatsuki	1993	NIFTS
Yuzora		○	○	Hakutou × Akatsuki	1983	NIFTS

Table 2-1. Continued.

Cultivar/selection	Exp.1	Exp.2	Exp.3	Pedigree	Year of cultivar registration or appearing in commercial or test production ^z	Origin
Canning peach						
Early Gold		○		Nishiki × Fortuna	1982	NIFTS
First Gold		○		Nishiki × Hiratsuka 39	1982	NIFTS
Kanto 5		○		(Ki × T 43) × (Kohai 3 × Orange Cling 9)	1956	NIFTS
Mochizuki	○	○	○	Momo Tsukuba 115 × 139-28	2000	NIFTS
Nishiki	○	○		Kanto 12 × Kanto 2	1964	NIFTS
Sweet Gold		○		Fortuna × Kanto 5	1982	NIFTS
Introduced for research use from other countries to Japan						
Chimarita		○		Babcock × Flordabelle	1987	Brazil
Elberta		○		Chinese Cling O.P.	1870	U.S.A.
EVG-2		○			-	
Hars on		○		Redskin × Sunhaven	1982	Canada
Maravilha		○		Sunred × (Okinawa × Hiland) O.P.	1975	U.S.A.
Taikobanto		○			-	China

Table 2-2. Analysis of variance of LLVs in the artificial inoculation test to shoot with 25 cultivars/selections from 2006 to 2008 (Exp.1).

Source of variation	Sum of square	d.f.	Mean square	F-value	Expected MS
Cultivar/selection	12.301	24	0.513	8.85 **	$\sigma_{e1}^2 + 3\sigma_{gy}^2 + 9\sigma_{gl}^2$
Year	0.128	2	0.064	1.10 NS	$\sigma_{el}^2 + 3\sigma_{gy}^2 + 75\sigma_y^2$
Cultivar \times year	5.052	48	0.105	1.81 **	$\sigma_{el}^2 + 3\sigma_{gy}^2$
Error	8.681	150	0.058		σ_{el}^2
Total	26.162	224			

NS, ** Nonsignificant ($P > 0.05$), or significant ($P < 0.01$), respectively.

Table 2-3. Variance components estimated by the analysis of variance for LLVs in the artificial inoculation test to shoot with 25 cultivars/selections from 2006 to 2008 (Exp.1).

Variance component	Estimate	Percentage of variance component to the sum of the variance components (%)
σ_{gI}^2 (cultivar)	0.045	37.8
σ_y^2 (year)	0	0.0
σ_{gy}^2 (cultivar \times year)	0.016	13.4
σ_{eI}^2 (error)	0.058	48.7

Table 2-4. Lesion length resulting from the artificial inoculation test to shoot with different inoculation times and inoculum concentrations (Exp. 3).

Cultivar/selection	Inoculum concentration	Lesion length (mm)				Average
		Inoculation time			July	
		May	June	June		
Momo Tsukuba 130	10^6 cfu \cdot mL ⁻¹	8.7 (0.505) ^z	10.4 (0.688)	11.8 (0.796)	10.3	
	10^8 cfu \cdot mL ⁻¹	9.2 (0.573)	14.9 (0.975)	16.4 (1.039)	13.5	
Akatsuki	10^6 cfu \cdot mL ⁻¹	6.4 (-0.060)	11.3 (0.763)	12.1 (0.823)	9.9	
	10^8 cfu \cdot mL ⁻¹	13.3 (0.893)	15.2 (0.986)	16.4 (1.038)	15.0	
Kawanakajima Hakutou	10^6 cfu \cdot mL ⁻¹	35.8 (1.482)	17.0 (1.061)	8.0 (0.395)	20.3	
	10^8 cfu \cdot mL ⁻¹	44.0 (1.586)	15.9 (1.018)	14.5 (0.957)	24.8	
Nakatsu Hakutou	10^6 cfu \cdot mL ⁻¹	44.2 (1.588)	40.0 (1.537)	27.7 (1.346)	37.3	
	10^8 cfu \cdot mL ⁻¹	53.6 (1.682)	32.7 (1.435)	29.2 (1.375)	38.5	
Mochizuki	10^6 cfu \cdot mL ⁻¹	6.0 (-0.312)	6.2 (-0.164)	5.9 (-0.428)	6.0	
	10^8 cfu \cdot mL ⁻¹	9.4 (0.595)	8.7 (0.504)	12.3 (0.832)	10.1	
Yuzora	10^6 cfu \cdot mL ⁻¹	8.5 (0.472)	16.4 (1.039)	16.5 (1.042)	13.8	
	10^8 cfu \cdot mL ⁻¹	12.9 (0.871)	15.9 (1.018)	16.8 (1.053)	15.2	
Average	10^6 cfu \cdot mL ⁻¹	18.3	16.9	13.7	16.3	
	10^8 cfu \cdot mL ⁻¹	23.8	17.2	17.6	19.5	

^zAverage lesion length of three shoots. Number in parentheses indicate LLVs.

Table 2-5. Analysis of variance for LLVs resulting from the artificial inoculation test to shoot under different inoculation conditions; inoculation time and inoculum concentration (Exp. 3).

Source of variation	Sum of square	d.f.	Mean square	F value	Expected MS
Cultivar/selection	17.550	5	3.510	119.26 **	$\sigma_{e_2}^2 + 18\kappa_{g_2}^2$
Inoculum concentration	3.275	1	3.275	111.26 **	$\sigma_{e_2}^2 + 54\kappa_c^2$
Inoculation time	0.139	2	0.069	2.35 NS	$\sigma_{e_2}^2 + 36\kappa_t^2$
Cultivar \times concentration	2.671	5	0.534	18.15 **	$\sigma_{e_2}^2 + 9\kappa_{gc}^2$
Cultivar \times time	4.071	10	0.407	13.83 **	$\sigma_{e_2}^2 + 6\kappa_{gt}^2$
Time \times concentration	0.303	2	0.152	5.15 **	$\sigma_{e_2}^2 + 18\kappa_{tc}^2$
Cultivar \times concentration \times time	1.188	10	0.119	4.04 **	$\sigma_{e_2}^2 + 3\kappa_{gct}^2$
Error	2.119	72	0.029		$\sigma_{e_2}^2$
Total	31.315	107			

NS, ** Nonsignificant ($P > 0.05$), or significant ($P < 0.01$), respectively.

Table 2-6. Variance components estimated by the analysis of variance for LLVs in the artificial inoculation test to shoot under different inoculation conditions; inoculation time (time) and inoculum concentration (conc.) (Exp. 3).

Variance component	Estimate	Percentage of each variance component to the sum of the variance components (%)
κ_{g^2} (cultivar)	0.193	44.0
κ_c^2 (conc.)	0.060	13.7
κ_t^2 (time)	0.001	0.3
κ_{gc}^2 (cultivar \times conc.)	0.056	12.8
κ_{gt}^2 (cultivar \times time)	0.063	14.3
κ_{tc}^2 (time \times conc.)	0.007	1.5
κ_{gtc}^2 (cultivar \times time \times conc.)	0.030	6.8
σ_{e^2} (error)	0.029	6.7

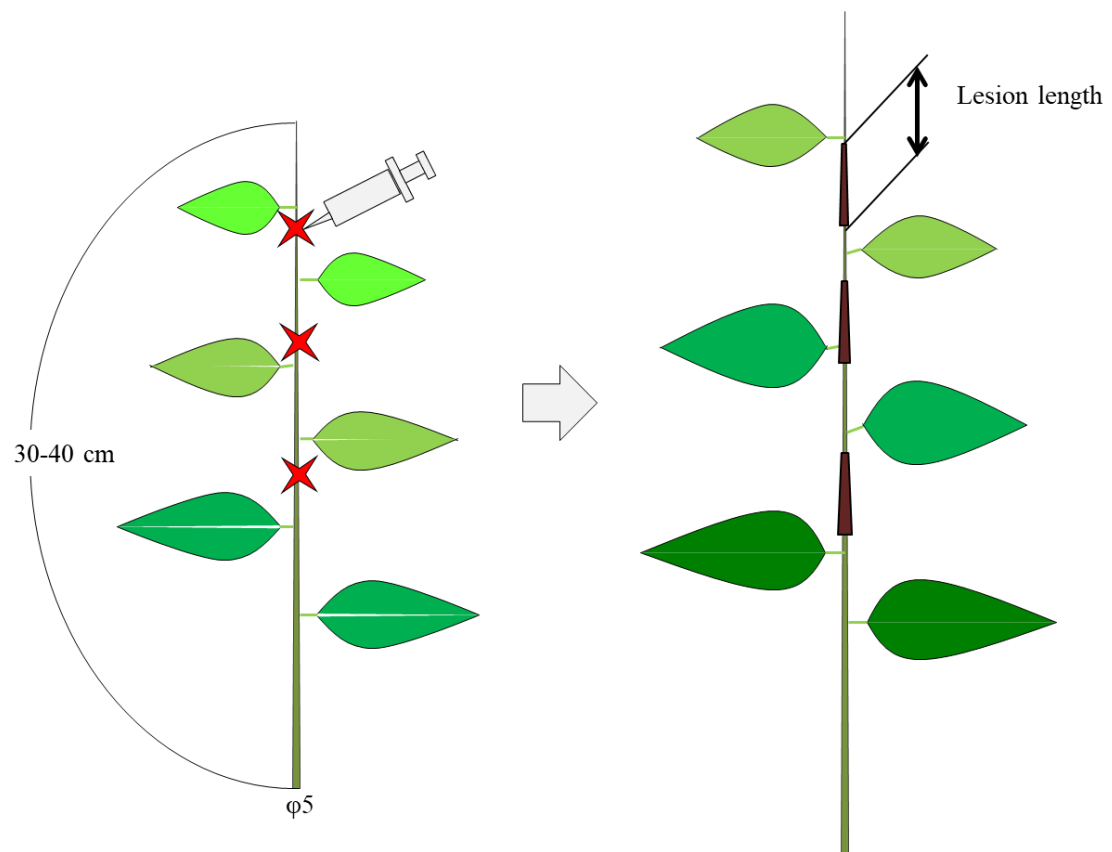

Fig. 2-1. Inoculation of shoots. Left: shoot at the time of inoculation. Right: shoot at the time of lesion length measurement.

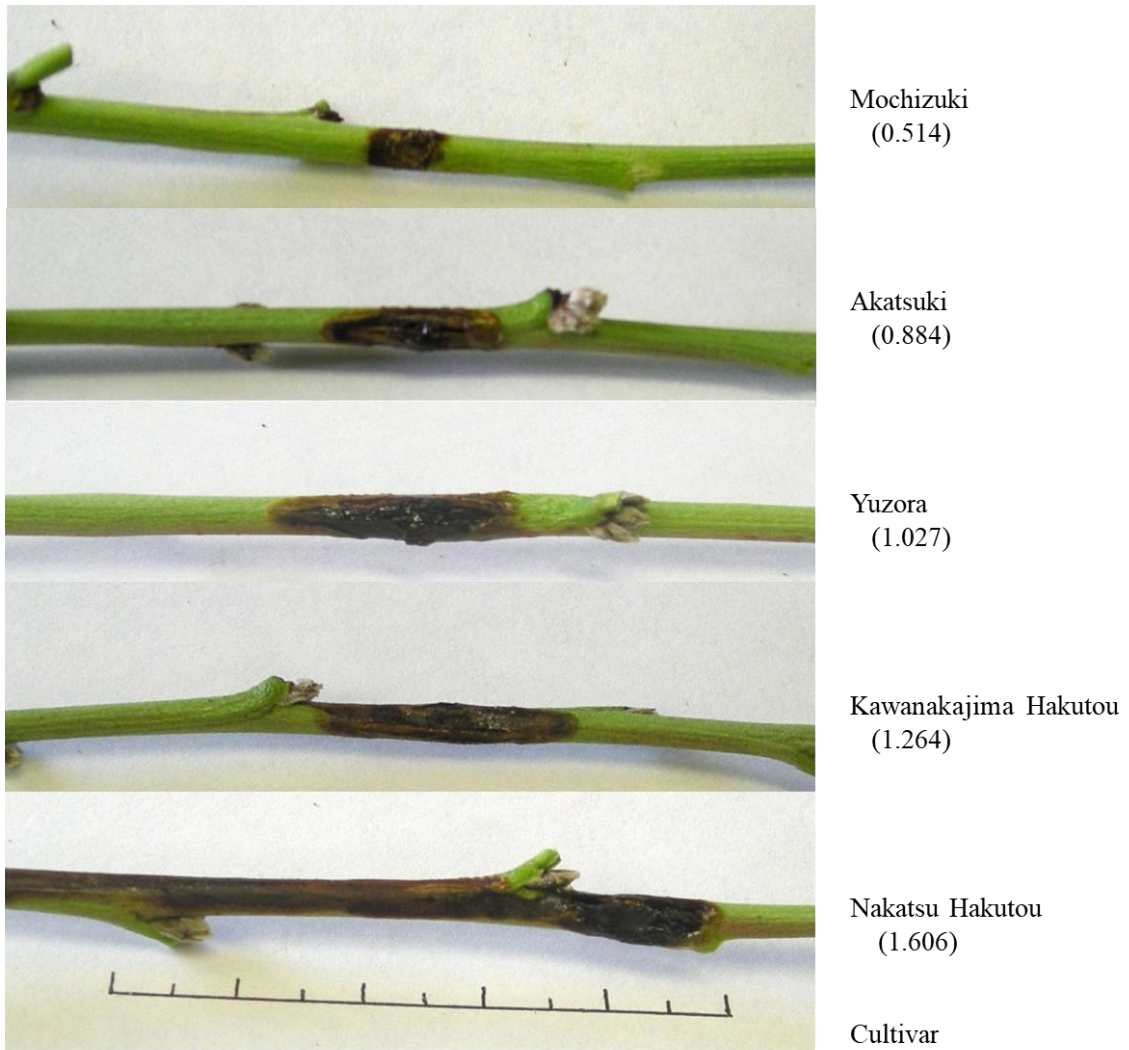

Fig. 2-2. Artificially inoculated lesions on current shoots of some cultivars. LLV is shown in parentheses. (Photographed by NIFTS)

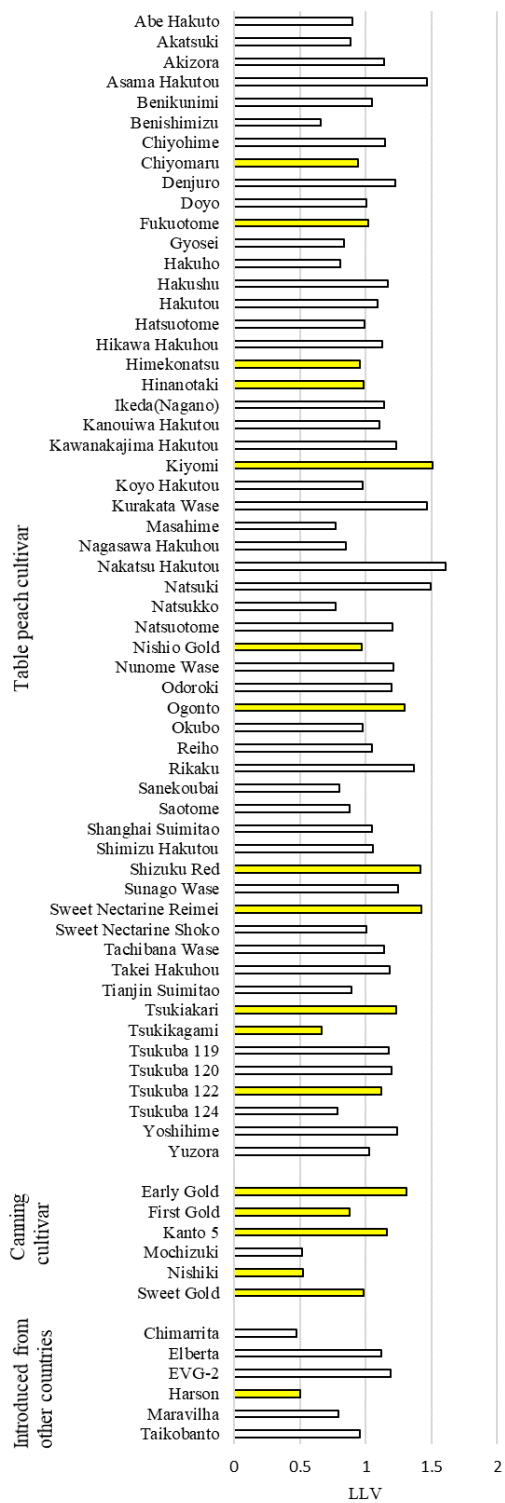

Fig. 2-3. Varietal differences in LLV of artificially inoculated peach shoots. (2006-2008). Yellow and white color of bar indicates yellow and white flesh color of cultivars/selections, respectively.



Fig. 2-4. Fruit of 'Chimarrita'. (Photographed by NIFTS)



Fig. 2-5. Fruit of 'Mochizuki'. (Photographed by NIFTS)

Chapter 3

Inheritance of susceptibility to bacterial spot in a population of offspring from crosses between Brazilian and Japanese cultivars/selections

Introduction

Bacterial spot caused by *X. arboricola* pv. *pruni* is one of the most important and serious diseases for commercial peach cultivation in Japan, especially in windy areas with heavy rainfall. The disease causes spots on the leaves, twigs, and fruit, resulting in severe defoliation. The presence of spots on fruits seriously reduces their marketability. Since it is difficult to control this bacterium completely by chemical applications, the use of resistant cultivars would be the most effective way to control this disease. However, complete resistant cultivars to bacterial spot are not known.

Varietal differences in susceptibility to bacterial spot were reported for peach, Japanese plum, apricot and other *Prunus* spp. in countries other than Japan by Du Plessis (1988), Keil and Fogle (1974), Martins and Raseira (1996), Medeiros *et al.* (2011), Randhawa and Civerolo (1985), Sherman and Lyrene (1981), and Werner *et al.* (1986). Several different evaluation methods were used in these studies, for example, orchard susceptibility observations (Keil and Fogle, 1974; Medeiros *et al.*, 2011; Sherman and Lyrene, 1981; Werner *et al.*, 1986), detached-leaf bioassays (Medeiros *et al.*, 2011; Randhawa and Civerolo, 1985) and greenhouse inoculation (Du Plessis, 1988; Martins and Raseira, 1996; Medeiros *et al.*, 2011).

In North Carolina in the United States, resistance breeding to peach bacterial spot had been carried out with the cooperation of phytopathologists and breeders, resulting that some

commercially resistant cultivars have been identified. Peach cultivars, ‘Biscoe’, ‘Candor’, ‘Emery’, ‘Norman’, ‘Pekin’, ‘Rubired’, ‘Troy’, ‘Whynot’ and ‘Winblo’ (Clayton, 1976). The most resistant cultivars from the breeding program in the US were ‘Candor’ and ‘Clayton’ (Okie *et al.*, 2008), however, these cultivars have not been introduced to Japan.

In earlier reports for varietal differences in resistance/susceptibility to bacterial spot did not include Japanese peach cultivars and genetic resources. The susceptibility in cultivars including economically important peach cultivars in Japan was observed and reported in several orchards (Kuraoka and Kato, 1955; Shiina *et al.*, 1966; Takanashi, 1978; Yamamoto *et al.*, 1953). They suggested varietal differences in resistance/susceptibility to bacterial spot, however, those reports did not conduct statistical analyses with experimental designs. The occurrence of bacterial spot fluctuates highly in different environmental conditions including rainfall, wind, temperature and bacterial density of the year prior to the experimental year.

In *Chapter 2*, I developed a new artificial shoot inoculation method and elucidated the genetic differences in susceptibility to bacterial spot for Japanese peach genetic resources, with appropriate statistical analyses. Relatively resistant cultivars were selected to bacterial spot such as a Brazilian cultivar ‘Chimarrita’, ‘Nishiki’ (Kajiura *et al.*, 1966) and ‘Mochizuki’ (Yamaguchi *et al.*, 2001) for canning use, and a Japanese table peach cultivar ‘Tsukikagami’ (Yaegaki *et al.*, 2016). I elucidated the magnitude of environmental variability in the observed values using artificial inoculation and averaged value with repetitions of three shoots repeated over two years had a considerably reduced environmental variance and resulted in broad-sense heritability of 0.71 for the 69 cultivars/selections.

In order to develop new resistant cultivars with high fruit quality and productivity, the inheritance of resistance must be elucidated. Sherman and Lyrene (1981) evaluated the susceptibility to bacterial spot in their low-chilling breeding germplasm in Florida, the US and hypothesized that resistance was controlled by a few genes. In addition, Yang *et al.*

(2013) investigated the inheritance of resistance using ‘Clayton’, suggesting that resistance to bacterial spot was controlled by quantitative trait loci (QTLs).

Peach breeding with the goal of combining excellent fruit quality for Japanese market with resistance to bacterial spot, started recently at the NIFTS (Tsukuba, Ibaraki, Japan), using peach genetic resources in Japan. The objective of this study was to identify the inheritance of bacterial spot resistance in a seedling population from NIFTS peach breeding programs using the artificial inoculation method, and to propose an effective way to efficiently accelerate the peach resistant breeding to bacterial spot.

Materials and Methods

Plant materials

Three to five year-old peach seedling trees of 514 offspring of 27 full-sib families (Figs. 3-1, 3-2) and their cross-parent (4 to 14 year-old) trees of 28 cultivars/selections (Table 3-1) with no tree replications were used in this study. Cultural practices were carried out in the same way for parental cultivars/selections as for the seedling population.

Here, the experiment had no tree replications within each genotype. Generally, tree effects may often be caused by differences in tree vigor. However, here, several 30–40 cm long current-year shoots with basal diameters of about 5 mm were chosen and inoculated artificially as previously described in the *Chapter 2*. Thus, sampling was not based on individual trees but multiple shoots with uniform vigor. In addition, the trees used in the experiment were pruned, the flower buds and fruit were thinned, fertilizer was applied, and the trees were irrigated under conditions that kept the trees uniform. Therefore, I assumed a minimum of tree effects within genotype, which were included in the genetic effect, and regarded the tree effects as negligible.

They were grown and maintained at the NIFTS (Tsukuba, Ibaraki, Japan). Their susceptibility to bacterial spot was evaluated by the artificial shoot inoculation method (described in *Chapter 2*) during 2006-2008. Offspring and cross-parents were evaluated in a single year or repeatedly for two years during 2006-2008, respectively. *Chapter 2* reported negligible and non-significant year effects during 2006-2008, therefore, I combined the data from all years.

Depending on the breeding objectives, crosses were divided into six “Brazilian crosses” (Fig. 3-1) and 21 “Japanese crosses” (Fig. 3-2). Brazilian crosses included the combinations of a Brazilian cultivar ‘Chimarrita’ crossed as a parent, and the combinations that selections (296-16, 332-16, and 333-13) were crossed as parents, derived from Brazilian cultivars ‘Chimarrita’ and ‘Coral’ (Figs. 3-2, 3-3). Japanese crosses included crosses among Japanese cultivars and selections, and some of which were partly derived from American cultivars. The former crosses were also conducted to develop cultivars with a low-chilling requirement and excellent quality for table use in Japan. The latter crosses were aimed to develop new commercial table peach cultivars with a high sugar content, low acidity, large fruit size and attractive appearance at various maturing times. Both Brazilian and Japanese crosses had no specific mating design. Some cultivars were repeatedly used as cross-parents. The number of offspring from a cross varied from five to 65 per family (Table 3-4). In the present study, I use the term “family” as the full-sib offspring population resulting from a cross.

Evaluation of peach bacterial spot

Evaluation of expansion resistance to bacterial spot was carried out in the same manner as described in the *Chapter 2*. *X. arboricola* pv. *pruni* (MAFF301420), supplied by the NGRC (Tsukuba, Ibaraki, Japan), was the inoculant, in this study. Bacteria growing on potato dextrose agar were suspended in sterile water and adjusted to 10^8 cfu·L⁻¹ and used for

inoculation. A syringe with ten 26-gauge needles was used to lightly wound the shoot surface, and the bacterial suspension was injected at each site. Several current-year shoots, 30–40 cm long with basal diameters of about 5 mm, from field-grown trees were artificially inoculated in June from 2006 to 2008. Inoculations consisted of three points at intervals of about 7 cm per shoot, three shoots per treatment. Inoculated shoots were collected, and lesion lengths were measured in late August or early September. Mock-inoculated shoots injected with sterile water, had an average lesion length of 5.5 mm in nine cultivars (control treatments, *Chapter 2*). Thus, the average lesion length for each shoot (X ; unit is millimeter) was reduced by 5.5 mm and log-transformed to improve normality. The average value of $\log_{10}(X-5.5)$ for the three shoots from each genotype (cultivar/selection and offspring) per year was used as the LLV (lesion length value) of the genotype in the year and was subjected to statistical analyses.

Statistical analyses

(1) Evaluation of parental cultivars/selections for estimating environmental variance

The LLV data evaluated for two years of 28 parental cultivars/selections were subjected to ANOVA in a one-way classification with genotype (cultivar/selection) as the factor.

The model was: $P_{ij} = \mu + G_i + E_{ij}$

P_{ij} : LLV of the j th year in the i th cultivar/selection, μ : overall mean, G_i : the effect of the i th cultivar/selection, E_{ij} : the residual environmental effect of the j th year of the i th cultivar/selection ($i=1$ to 28, $j=1$ to 2). The ANOVA provided estimates of variance components for genetic variance (σ_g^2) and environmental variance (σ_{e1}^2).

(2) Evaluation of offspring for estimating between-family and within-family variance in Japanese crosses

Five offspring per full-sib family were randomly chosen from offspring in 21 crosses among Japanese cultivars/selections, and the LLV data of those offspring were subjected to ANOVA in a one-way classification with family as the factor. The model was:

$$P_{ij} = \mu + B_i + W_{ij}$$

P_{ij} : LLV of the j th offspring in the i th family (cross), μ : overall mean, B_i : the effect of the i th family, W_{ij} : the variance of the j th offspring of the i th family ($i=1$ to 21, $j=1$ to 5).

The homogeneity of within-family variances in LLVs was tested by Bartlett's test (Snedecor and Cochran, 1972), and the normal distribution of residual estimates was tested using Kolmogorov-Smirnov one-sample test (Campbell, 1974). The homogeneity of the variances was not rejected at $P = 0.05$, and the residual distribution approached a normal distribution at $P = 0.05$, indicating that ANOVA was applicable to the data.

The ANOVA provided estimates of variance components as follows: between-family variance (σ_b^2) and within-family variance (σ_w^2). The σ_{e1}^2 obtained for parental cultivars/selections (1) was used as the within-family environmental variance (σ_{we}^2), and the within-family genetic variance (σ_{wg}^2) was calculated by $\sigma_w^2 - \sigma_{we}^2$.

(3) Regression of family mean on mid-parental values and ANOVA for offspring in Japanese crosses

According to methods described by Yamada (2011), Yamada *et al.* (1995, 1997), and Sato *et al.* (2006), ANOVA and estimation of variance components was performed, and regression analysis was performed for family mean (the mean LLV for five offspring in a family) on the mid-parental value, which was the mean LLV for seed and pollen parents for offspring from the 21 crosses among Japanese cultivars/selections. The genetic model was as follows:

$$Y_{ij} = \mu + \beta (X_i - \bar{X}) + d_i + W_{ij}$$

where Y_{ij} : phenotypic value of the j th offspring in the i th family

μ : overall mean (constant)

β : the regression coefficient of family mean on mid-parental value

X_i : mid-parental value in the i th family

\bar{X} : the mean of all the mid-parental values

d_i : the deviation of the i th family mean from the regression line

W_{ij} : the within-family effect of offspring in the j th offspring of the i th family

The W_{ij} was divided into wg_{ij} and we_{ij} , the genetic and environmental effect of the j th offspring of the i th family, respectively.

Results

Estimation of environmental variance using parental cultivars/selections.

The resistance/susceptibility to bacterial spot was evaluated for 28 cross-parents, including four cultivars/selections derived from Brazilian cultivars/selections and 24 cultivars/selections derived from Japanese cultivars/selections (partly from American cultivars). Although bacterial spot lesions showed black necrotic regions for all tested cross-parents (Fig. 3-4), necrotic lesion lengths showed differences among cross-parents and were larger than control treatments. The average lesion length for the nine cultivars ('Akatsuki', 'Chiyohime', 'Harrow Beauty', 'Manami', 'Masahime', 'Mochizuki', 'Natsuotome', 'Nishiki' and 'Shimizu Hakutou') wounded and injected with sterile water as the control in the same way as the artificially inoculated shoots was 5.5 mm. The average lesion length for each shoot (X ; unit is millimeter) was reduced by 5.5 mm and log-transformed to improve normality.

LLVs for 28 cross-parents evaluated repeatedly for two years were subjected to ANOVA in a one-way classification with genotype (cultivar/selection) as the factor. The

genetic effect was highly significant (Table 3-2). The genetic (σ_g^2) and environmental (σ_e^2) variances were estimated at 41.75×10^{-3} and 43.95×10^{-3} , respectively.

Susceptibility to bacterial spot for cross-parents

The LLVs were summarized for seed and pollen parents and the family-means in Table 3-3, which represented the mean value of offspring from a cross. The average LLVs for a total of 28 cultivars/selections used as cross-parents for two years in 27 crosses varied from 0.302 (selection 333-13) to 1.295 (selection 346-23) (Table 3-3). For Brazilian crosses, three cultivars/selections of ‘Chimarrita’, and selections 333-13 and 296-16 derived from Brazilian cultivars (‘Chimarrita’ and ‘Coral’), had the LLV less than 0.5. Here, I referred to cultivars of Brazilian origin and selections partly derived from them as “Brazilian cultivars/selections”. A Brazilian selection, 332-16, with a high LLV (0.981) was crossed with Brazilian selections having low LLVs (selections 296-16 and 333-13).

In contrast, all cross-parents in the Japanese crosses had LLVs of 0.5 or more. ‘Mochizuki’ and ‘Tsukikagami’ had relatively low LLVs among Japanese cross-parents, and their LLVs were 0.514 and 0.667, respectively (Table 3-4).

Susceptibility to bacterial spot for Brazilian crosses

The family means of LLVs in the six Brazilian crosses (cross nos. 381, 384, 402, 403, 404 and 405) were generally low, ranging from 0.402 to 0.576, as compared with the family means of LLVs in Japanese crosses ranging from 0.719 to 1.194. The family means in six Brazilian crosses were nearly the same as (or close to) both or one of the Brazilian cultivar/selection parents having low LLVs.

In the “381” family, which was resulted from the cross between both parents having low LLVs (296-16 \times ‘Chimarrita’), the difference between the family mean (0.561) and the

seed or pollen parental values (0.490 or 0.476) seemed to be within the expected range for environmental variation.

The other five crosses were between Brazilian cultivars/selections having low LLVs (less than 0.5) and cultivars/selections with high LLVs (0.981 to 1.295). Family means in four crosses of 384, 403, 404 and 405 were less than 0.5. The family mean in the cross 296-16 × 332-16 (cross no. 402) was 0.576, whose value is much closer to the low LLV of the Brazilian parent 296-16.

The homoscedasticity between the environmental variance (σ_{e1}^2) in seed or pollen parental LLVs and the within-family variance was tested by an F-test. Those variances were not significantly different in four crosses including 296-16 × 'Chimarrita' (cross no. 381) but were significantly different at $P = 0.05$ for one cross (cross no. 404, 346-23 × 'Chimarrita') and at $P = 0.01$ for one cross (cross no. 403, 'Kawanakajima Hakutou' × 'Chimarrita'), respectively. Therefore, the difference between the seed or pollen parental values and the family mean was tested using the Behrens-Fisher test with an approximate significance level by Cochran (1964) according to Snedecor and Cochran (1972). As a result, family means were separated from all seed or pollen parental values of the higher LLV cultivars/selections (Table 3-3).

Susceptibility to bacterial spot for Japanese crosses

The family means of LLVs in the 21 Japanese crosses ranged from 0.719 to 1.194, whose values were much higher than those in the Brazilian crosses (0.402 to 0.576) (Table 3-3). ANOVA for five offspring per family in 21 families from Japanese crosses detected a significant effect due to family ($P < 0.05$) (Table 3-5). The between-family (σ_b^2) and within-family (σ_w^2) variances were estimated at 10.992×10^{-3} and 54.280×10^{-3} , respectively, of which 16.8% and 83.2% of the total variance was in the entire ANOVA offspring population

(Table 3-6). As within-family environmental variance was assumed to be σ_{e1}^2 among parental cultivars/selections, the within-family variance was divided into within-family genetic variance (σ_{wg}^2 : 10.332×10^{-3}) and within-family environmental variance (σ_{we}^2 : 43.948×10^{-3}).

Regression of family mean to mid-parental values was not significant at $P = 0.05$ (Fig. 3-5, Table 3-5). The between-family variance was divided into the variance explained by the regression (σ_r^2 : 0.699×10^{-3} ; 6% of the between-family variance) and the residual variance from the regression (σ_d^2 : 10.293×10^{-3} ; 94% of the between-family variance). The variance in the mid-parental value was estimated at 17.375×10^{-3} , and the environmental variance of the mid-parental value was estimated at $\sigma_{e1}^2/2$: 21.974×10^{-3} . Therefore, the genetic variance of the mid-parental value was negligible in the population. This result could be a probable reason for the negligible variance explained by the regression. The regression is associated with additive gene effects (Yamada, 2011), which is negligible in the population to be analyzed.

The total genetic variance was estimated as $\sigma_b^2 + \sigma_{wg}^2$ (21.324×10^{-3}), which represents only approximately one-half of σ_{e1}^2 (Table 3-6). The σ_b^2 and σ_{wg}^2 accounted for 52% and 48% of the total genetic variance, respectively, indicating that around one-half of the total genetic variation in the offspring population was due to between-family and within-family genetic variation, respectively. The large environmental variation indicated by σ_{we}^2 masked the genetic variation. The broad-sense heritability in a family for LLVs for an offspring defined as $\sigma_{wg}^2 / (\sigma_{wg}^2 + \sigma_{we}^2)$ was estimated at only 0.19.

Discussion

Since bacterial spot disease is difficult to control under windy and humid climate conditions, resistant cultivars are desired for commercial production in peach. Although varietal differences in susceptibility were partly reported, the mode of inheritance remains unclear and resistance breeding to bacterial spot has been rarely carried out in Japanese peach breeding program. In North Carolina (US), resistant breeding to bacterial spot has been preliminarily carried out over decades, resulting that several resistant cultivars were released (Clayton, 1976; Okie *et al.*, 2008). However, the well-organized breeding process was not established. In Brazil, peach cultivar/selections A334, Cascata 1020, Conserva 930, and ‘Cristal Taquari’ showed some degree of resistance and were used for breeding programs (Raseira and Bonifacio, 2006). In this study, two patterns of inheritance were clarified for resistance to bacterial spot. Resistance derived from Brazilian cultivars including ‘Chimarrita’ is controlled by a QTL with large effect, and another resistance is controlled by QTLs with small effects. The resistance of Japanese peaches ‘Mochizuki’ and ‘Tsukikagami’ may be the latter type. Elucidation of the mode of resistance inheritance will be useful to accelerate the resistant breeding to bacterial spot in peach.

LLVs of family means of Brazilian crosses were low and close to the LLVs of Brazilian cultivar/selection parents for crosses between Brazilian cultivars/selections having low LLVs and cultivars/selections having high LLVs. Those family means were rather low, separated from all seed or pollen parental values of the higher LLV cultivars/selections. In addition, the within-family variances were not significantly different from the environmental variance estimate in four Brazilian crosses. These results suggested that bacterial spot resistance is controlled by a QTL with a large effect in the case of “Brazilian crosses”, and that the low LLV Brazilian cultivar/selection parents are dominant homozygotes (genotype: AA) and the Japanese cultivar/selection and 332-16 parents are recessive homozygotes (genotype: aa). In above case, all offspring would be heterozygotes (genotype: Aa) in the five crosses of

“Brazilian crosses” (family nos. 384, 402, 403, 404 and 405), resulting in the similar phenotypic values for the offspring as the Brazilian cultivar/selection parent having low LLVs. Differences in LLVs between family means and the Brazilian parents having low LLVs may be due to environmental variation and additional minor gene effects.

In the “381” family, family mean did not significantly separate from both seed and pollen parental values. In addition, there were no significant differences between within-family variance and environmental variance (σ_{e1}^2) for the four Brazilian crosses. These results suggested little effect of the additional minor genes for those crosses.

Based on the above results, the selection 296-16 genotype in the locus was supposed to be a dominant homozygote (genotype: AA); however, 296-16 is an offspring from a cross between ‘Yoshihime’ (seed parent; a Japanese cultivar, with an LLV of 1.236 in the present study) and ‘Coral’ (pollen parent; a Brazilian cultivar; its LLV has not been evaluated). Normally, the cross yielded all offspring with Aa or aa genotypes even if the genotype of ‘Coral’ was AA or Aa. Some doubling of a section of chromosome during recombination may happen rarely but is possible. Also, some interactive effect may be possible among genes. In addition, crossing may be very rarely, but possibly, mistaken. There is no information on the response of ‘Coral’ to bacterial spot, and it is unknown whether the resistance of ‘Chimarrita’ and ‘Coral’ originates from their common ancestor (Fig. 3-6). Therefore, the gene effects and genotype in the selection 296-16 are still unknown and should be elucidated in future studies.

For the Japanese crosses, I frequently used the following cultivars as cross-parents that had desirable characteristics related to our breeding objectives, i.e., ‘Yuzora’, a late maturing cultivar with a high sugar content; ‘Tsukiakari’, a middle maturing cultivar with a high sugar content, and Momo Tsukuba 124, an early maturing selection with large fruit. In the present study, ‘Yuzora’, ‘Tsukiakari’ and Momo Tsukuba 124 were used as cross-parents for six, four

and four times, respectively. These crosses were conducted without information about bacterial spot resistance in these cultivars/selections. Almost all widely grown cultivars in Japan are descendants of ‘Hakutou’ (Yamamoto *et al.*, 2003). Peach does not have self-incompatibility, and inbreeding depression, and selfing and backcrossing has been repeatedly used in the breeding, resulting in very narrow genetic variability (Scorza *et al.*, 1985; Yamamoto *et al.*, 2003). Most Japanese cultivars/selections used as cross-parents are closely related, which may have resulted in the narrow genetic variation in mid-parent for LLV and small value of broad-sense heritability (0.19).

In *Chapter 2*, I found that ‘Mochizuki’ had a relatively low LLV (0.514 ± 0.157). This cultivar was crossed with cultivars having large LLVs (‘Hakushu’, LLV:1.172; ‘Tsukiakari’, LLV:1.090), and the family-means in families resulting from those crosses were 0.746 (No. 396, Fig. 3-7j) and 0.779 (No. 397, Fig. 3-7k), whose values were not very close to the LLV of ‘Mochizuki’. In addition, the within-family variance was estimated as very small. Those results indicated that the relatively low LLVs of ‘Mochizuki’ was not inherited to offspring like that of Brazilian parents having low LLVs.

The present study revealed that resistance to bacterial spot controlled by a QTL with a large effect was derived from Brazilian cultivars, and that offspring with low LLV could be obtained easily from Brazilian crosses with parents having low LLVs. In contrast, it was difficult to obtain offspring with low LLVs from Japanese crosses, because their resistance to bacterial spot was controlled by a lot of QTLs with small effects. Japanese cultivars/selections have high eating quality and large fruit size, which assumed to be inherited quantitatively. Therefore, Japanese cultivars/selections used as cross-parents are indispensable to developing new cultivars with excellent marketability in Japan. In conclusion, it is an effective way to backcross repeatedly Brazilian cultivar/selection having

low LLV with Japanese cultivars/selections having high fruit quality in order to develop new cultivars combined bacterial spot resistance and high fruit quality in Japan.

Table 3-1. List of 28 cultivars/selections used as cross-parents and their origins

Cultivar/selection	Pedigree	JP accession No. ^z
Cultivars/selections derived from Brazilian cultivars (Chimarrita and Coral)		
296-16	Yoshihime × Coral	
332-16	Akatsuki × 297-2 (Chiyohime × Coral)	
333-13	296-16 × 296-16	
Chimarrita	Babcock × Flordabelle	236168
Cultivars/selections derived from Japanese cultivars partly from American cultivars		
316-2	Momo Tsukuba 103 × Fantasia	
317-25	Kawanakajima Hakutou × Gyosei	
319-25	Kawanakajima Hakutou × Hikawa Hakuhou	
338-15	Yoshihime × 281-32	
346-23	Masahime × Natsuotome	
348-35	Kawanakajima Hakutou × Tsukikagami	
Akatsuki	Hakutou × Hakuhou	112519
Akizora	Nishino Hakutou × Akatsuki	112600
Benikunimi	Akatsuki open pollinated seedling	230016
Hakuhou	Hakutou × Tachibana Wase	112532
Hakushu	U-9 × C2R19T182	239295
Himekonatsu	182-3 open pollinated seedling	239297
Kawanakajima Hakutou	Chance seedling	
Masahime	21-18 × Akatsuki	112598
Mochizuki	Momo Tsukuba 115 × 139-28	239296
Momo Tsukuba 119	Momo Tsukuba 116 × 203-1	
Momo Tsukuba 122	Sunglo × 135-37	
Momo Tsukuba 124	Kawanakajima Hakutou × 252-4	
Natsuotome	Akatsuki × Yoshihime	239294
Shimizu Hakutou	Chance seedling	112574
Tsukiakari	Masahime × Akatsuki	239298
Tsukikagami	Momo Tsukuba 115 × Momo Tsukuba 105	242682
Yoshihime	21-18 × Akatsuki	112597
Yuzora	Hakutou × Akatsuki	112586

^zAccession numbers in the NARO Genebank (http://www.gene.affrc.go.jp/index_en.php).

Table 3-2. Analysis of variance in a one-way classification with genotype (cultivar/selection) as the factor for LLV data of 28 parental cultivars/selections with two-year repetitions

Source of variation	Sum of squares	Degree of freedom	Mean squares	F - value	Expected mean squares
Genotype	3.44112	27	0.12745	2.900 **	$\sigma_{el}^2 + 2\sigma_{gl}^2$
Residual	1.23056	28	0.04395		σ_{el}^2
Total	4.67167	55			

** indicates significant at $P < 0.01$.

Table 3-3. Lesion length values (LLV) of cross-parents, mid-parent, and family mean in progenies for crosses having one or both parents derived from Brazilian cultivars

Cross number	Seed parent	Pollen parent	Number of evaluated offspring	Seed parent ^y	Pollen parent ^y	Lesion length value (LLV) ^z			
						Mid-parent	Family mean \pm SE ^x	Mean separation between parent and family mean ^w	Mean separation between pollen parent and family mean ^w
381	296-16	Chimarrita	6	0.490	0.476	0.483	0.561 \pm 0.062	NS	NS
384	333-13	332-16	9	0.302	0.981	0.642	0.434 \pm 0.100	NS	**
402	296-16	332-16	13	0.490	0.981	0.736	0.576 \pm 0.079	NS	*
403	Kawanakajima Hakutou	Chimarrita	30	1.177	0.476	0.827	0.402 \pm 0.069	**	NS
404	346-23	Chimarrita	9	1.295	0.476	0.886	0.474 \pm 0.044	**	NS
405	296-16	Tsukiakari	11	0.490	1.090	0.790	0.446 \pm 0.075	NS	**

^zLesion length value is the average value of log-transformed data from three shoots.

^yLLV in seed and pollen parent had the environmental variance (σ_{el}^2).

^xSE was calculated as the square root of each within-family variance divided by number of evaluated offspring in the family.

^wBehrens-Fisher test with approximate significance level by Cochran (1964) according to Snedecor and Cochran (1972). NS, *, ** indicates nonsignificant, significant at $P < 0.05$, or 0.01, respectively.

Table 3-4. Lesion length values (LLV) of cross-parents, mid-parent, and family mean in progenies for crosses having both parents derived from Japanese cultivars

Cross number	Seed parent	Pollen parent	Number of evaluated offspring	Lesion length value (LLV) ^z		
				Seed parent ^y	Pollen parent ^y	Family mean \pm SE ^x
354	Shimizu Hakutou	Momo Tsukuba 119	23	1.052	1.172	1.112 ± 0.067
371	Benikunimi	Himekonatsu	9	1.048	0.955	1.002 ± 0.109
374	Natsuotome	Momo Tsukuba 122	18	1.171	1.119	1.145 ± 0.069
375	Yuzora	Momo Tsukuba 122	5	1.027	1.119	1.073 ± 0.169
386	Hakuhou	Momo Tsukuba 124	7	0.810	0.786	0.798 ± 0.090
387	Akatsuki	Momo Tsukuba 124	7	0.884	0.786	0.835 ± 0.066
390	Akizora	Momo Tsukuba 124	17	1.142	0.786	0.964 ± 0.049
396	Mochizuki	Hakushu	19	0.514	1.172	0.843 ± 0.060
397	Mochizuki	Tsukiakari	29	0.514	1.090	0.802 ± 0.054
398	Masahime	348-35	7	0.827	0.882	0.855 ± 0.104
406	Kawanakajima Hakutou	Yuzora	27	1.177	1.027	1.102 ± 0.055
407	Yuzora	Tsukikagami	65	1.027	0.667	0.847 ± 0.033
410	Natsuotome	Yuzora	23	1.171	1.027	1.099 ± 0.034
411	317-25	Yuzora	15	0.579	1.027	0.803 ± 0.038
413	Yuzora	319-25	22	1.027	1.143	1.085 ± 0.052
414	346-23	Tsukiakari	37	1.295	1.090	1.193 ± 0.030
415	348-35	Tsukiakari	32	0.882	1.090	0.986 ± 0.047
416	Yoshihime	Momo Tsukuba 124	43	1.236	0.786	1.011 ± 0.046
418	Masahime	338-15	17	0.827	0.896	0.862 ± 0.049
419	Natsuotome	338-15	8	1.171	0.896	1.034 ± 0.086
N-128	316-2	Tsukikagami	6	0.973	0.667	0.820 ± 0.068

^zLesion length value is the average value of log-transformed data from three shoots.

^yLLV in seed and pollen parent had the environmental variance (σ_{el}^2).

^xSE was calculated as the square root of each within-family variance divided by number of evaluated offspring in the family.

Table 3-5. Analysis of variance for LLV in a one-way classification with family as the factor of the family and regression of family-mean on mid-parent for 21 families each with five offspring from crosses among Japanese cultivars/selections

Source of variation	Sum of squares	Degree of freedom	Mean squares	Expected mean squares ^y
Between-family	2.185	20	0.1092 *	$\sigma_w^2 + 5\sigma_b^2$
Regression ^z	0.176	1	0.1757 NS	$\sigma_w^2 + 5\sigma_d^2 + (5 \times 20)\sigma_r^2$
Residual	2.009	19	0.1057 *	$\sigma_w^2 + 5\sigma_d^2$
Within-family	4.560	84	0.0543	σ_w^2
Total		104	0.0586	

^zRegression of family mean on mid-parent value.

NS,* indicate nonsignificant or significant at $P < 0.05$, respectively.

^y σ_w^2 : within-family variance; σ_b^2 : between-family variance; σ_r^2 : variance explained by the regression; σ_d^2 : residual variance.

Table 3-6. Estimates of variance components for LLV in 21 families each with five offspring from crosses among Japanese cultivars/selections

Variance components		Estimated value (10^{-3})	Percentage of variance components (%)
Between-family	σ_b^2	10.992	16.8
Regression	σ_r^2	0.699	1.1
Residual	σ_d^2	10.293	15.8
Within-family	σ_w^2	54.280	83.2
Genetic	σ_{wg}^2	10.332	15.8
Environment	σ_{we}^2	43.948	67.3
Total		65.273	100.0

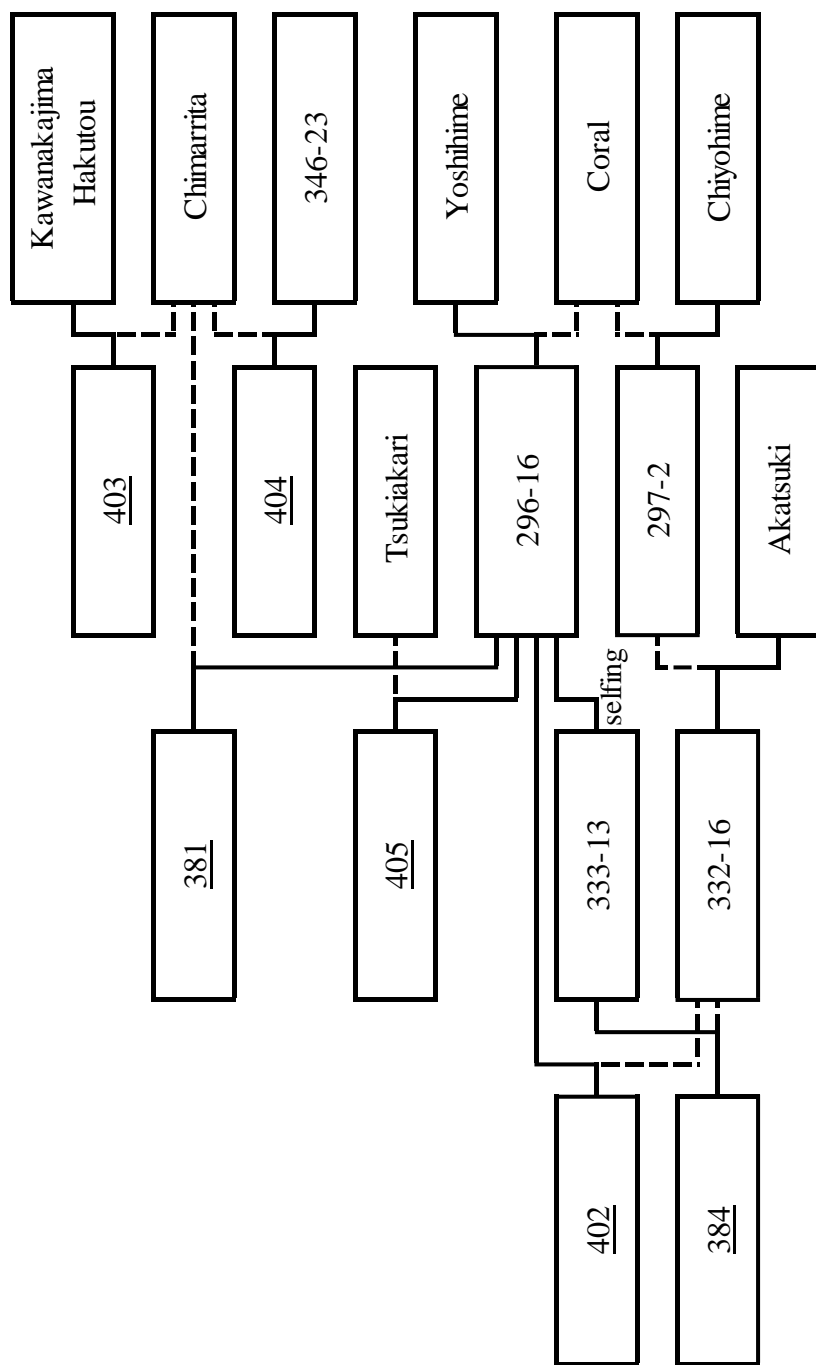

Fig. 3-1. Pedigree of 'Chimarrita' and 'Coral' derived families.

Solid and dotted lines indicate the seed parent and pollen parent, respectively.

Underlined numbers indicate cross family.

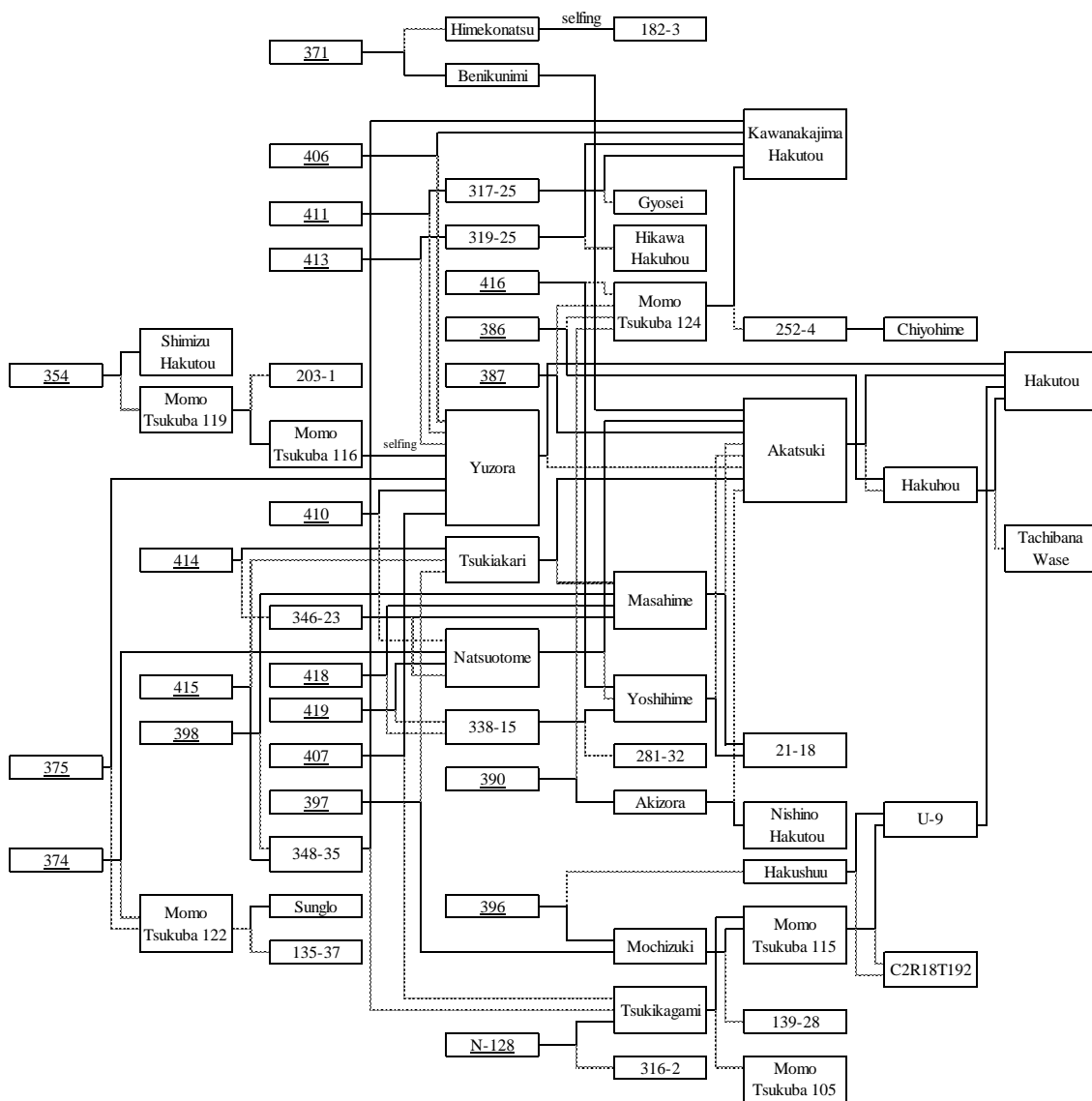

Fig. 3-2. Pedigree of Japanese crosses.

Underlined numbers indicate cross family.



Fig. 3-3. Fruit of 'Coral'. (Photographed by NIFTS)



Fig. 3-4. Artificially inoculated lesions on current shoots to bacterial spot for peach cultivars ‘Yuzora’ (A) and ‘Mochizuki’ (B). Lesion length values (LLVs) of ‘Yuzora’ and ‘Mochizuki’ were shown as 1.027 and 0.514, respectively. (Photographed by NIFTS)

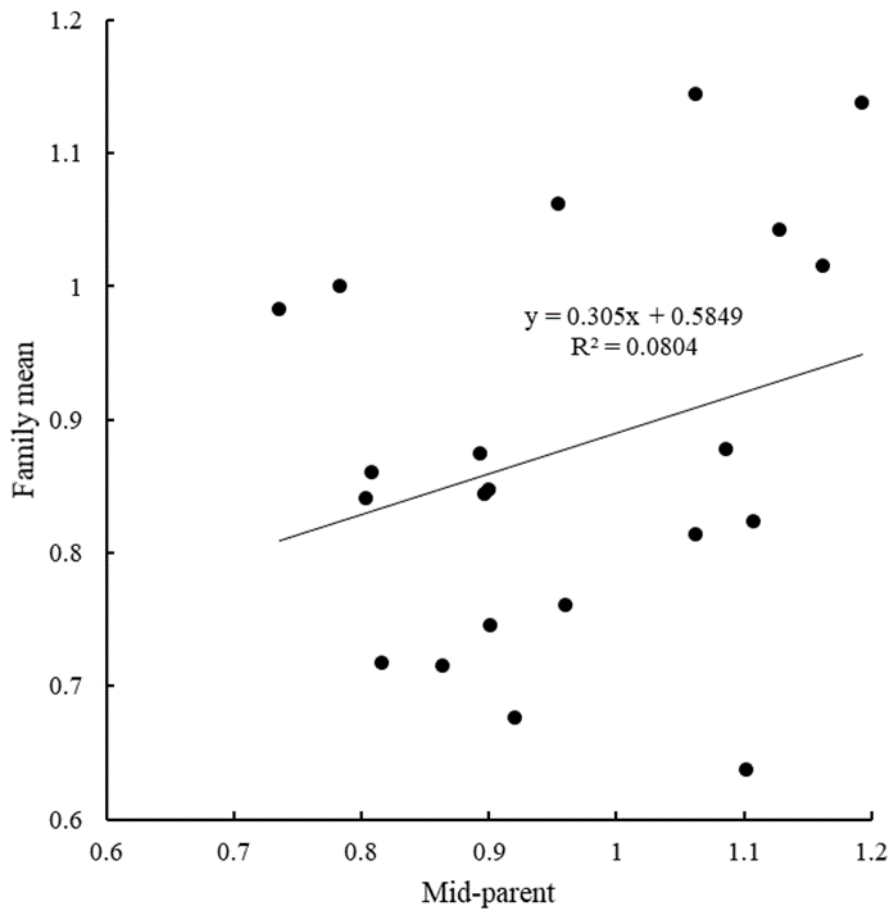

Fig. 3-5. Regression of the family mean of LLV on mid-parental values for offspring in Japanese crosses.

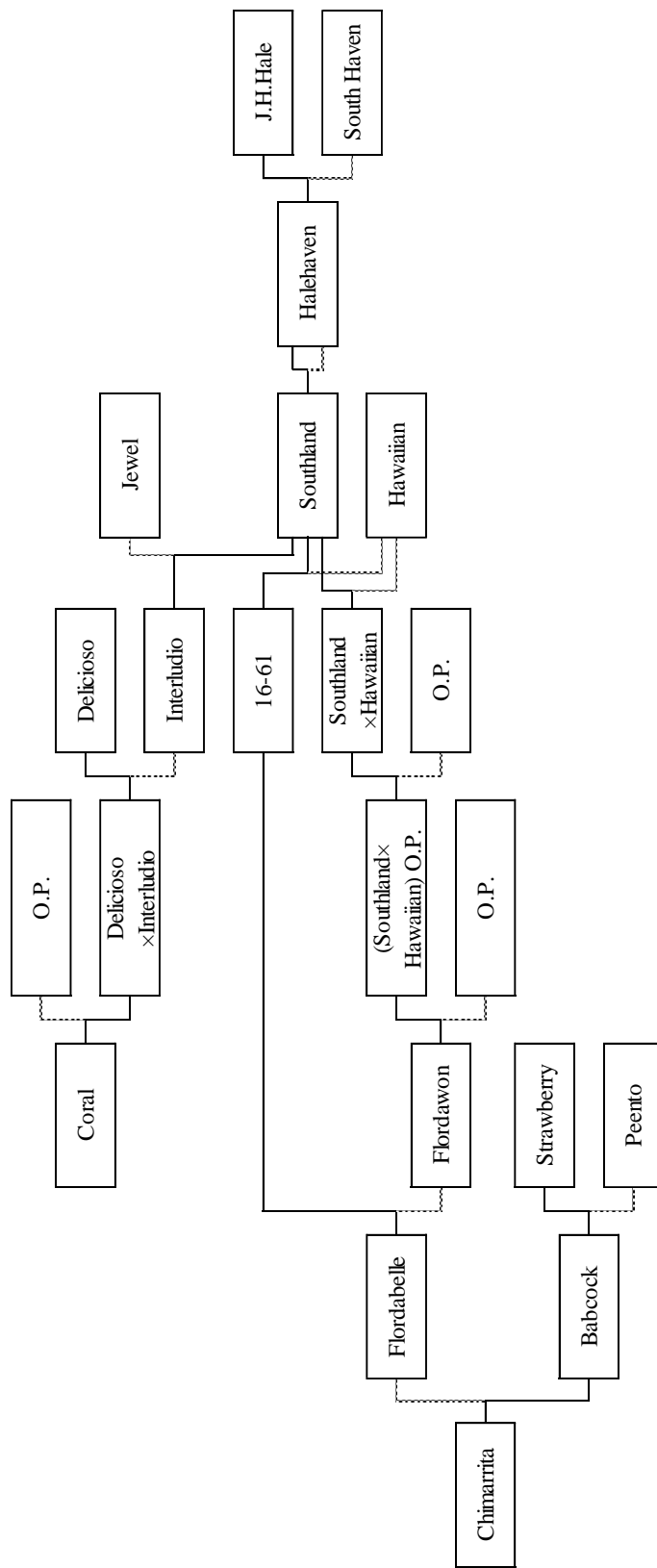

Fig. 3-6. Pedigree of 'Chimarrita' and 'Coral'.

Solid and dotted lines indicate the seed parent and pollen parent, respectively.

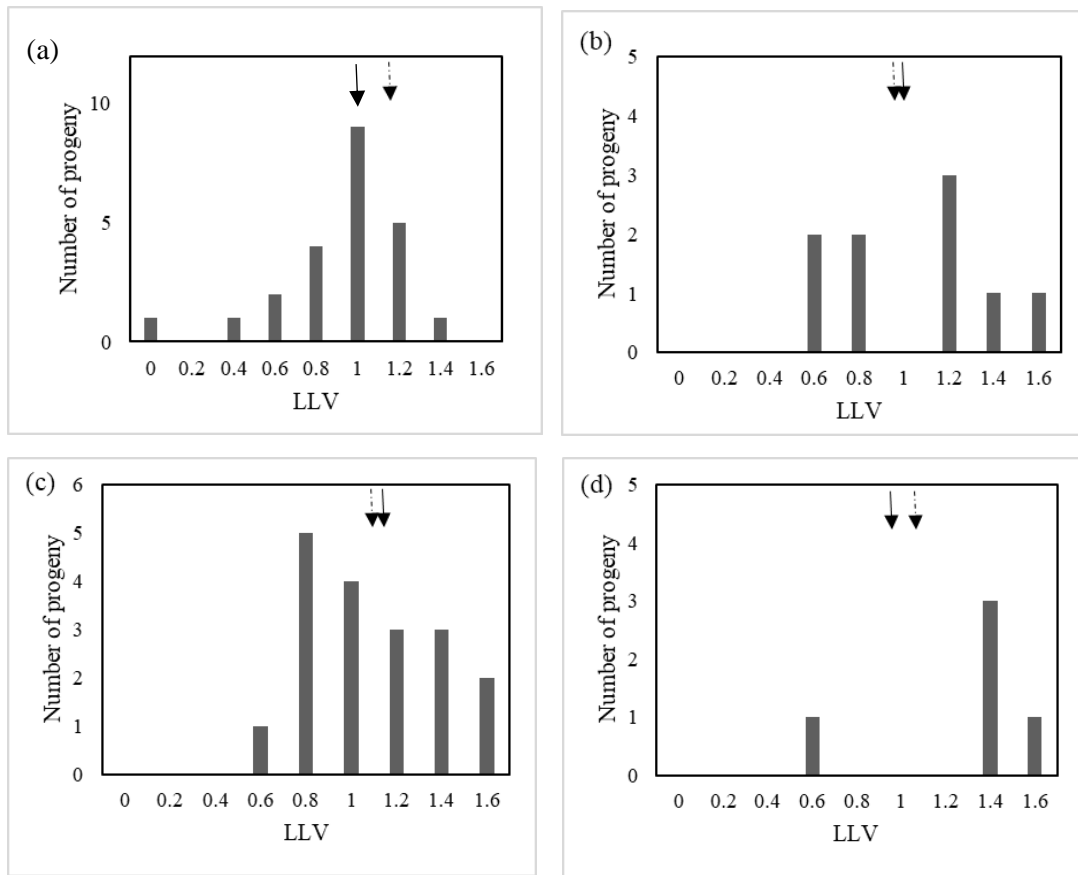

Fig. 3-7. Frequency distribution of lesion length values (LLVs) to bacterial spot for 27 peach F1 family. Solid and dashed arrows indicate seed and pollen parents, respectively. Family nos. and their cross combinations were listed below. ‘Brazilian crosses’ are underlined.

(a) 354 (Shimizu Hakutou × Momo Tsukuba 119); (b) 371 (Benikunimi × Himekonatsu); (c) 374 (Natsuotome × Momo Tsukuba 122); (d) 375 (Yuzora × Momo Tsukuba 122); (e) 381 (296-16 × Chimarrita); (f) 384 (333-13 × 332-16); (g) 386 (Hakuhou × Momo Tsukuba 124); (h) 387 (Akatsuki × Momo Tsukuba 124); (i) 390 (Akizora × Momo Tsukuba 124); (j) 396 (Mochizuki × Hakushu); (k) 397 (Mochizuki × Tsukiakari); (l) 398 (Masahime × 348-35); (m) 402 (296-16 × 332-16); (n) 403 (Kawanakajima Hakutou × Chimarrita); (o) 404 (346-23 × Chimarrita); (p) 405 (296-16 × Tsukiakari); (q) 406 (Kawanakajima Hakutou × Yuzora); (r) 407 (Yuzora × Tsukikagami); (s) 410 (Natsuotome × Yuzora); (t) 411 (317-25 × Yuzora); (u) 413 (Yuzora × 319-25); (v) 414 (346-23 × Tsukiakari); (w) 415 (348-35 × Tsukiakari); (x) 416 (Yoshihime × Momo Tsukuba 124), (y) 418 (Masahime × 338-15), (z) 419 (Natsuotome × 338-15); (aa) N-128 (316-2 × Tsukikagami).

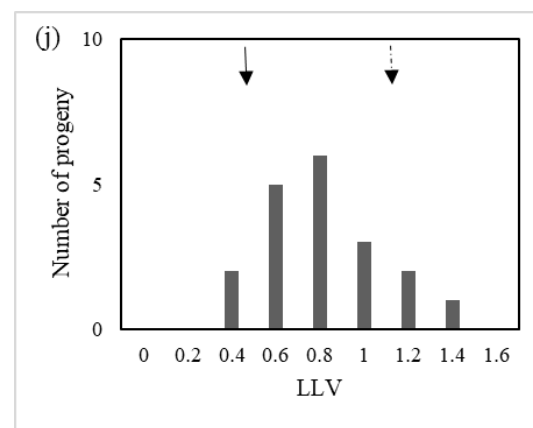
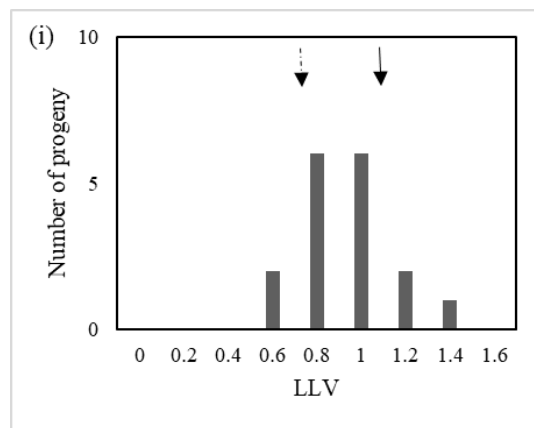
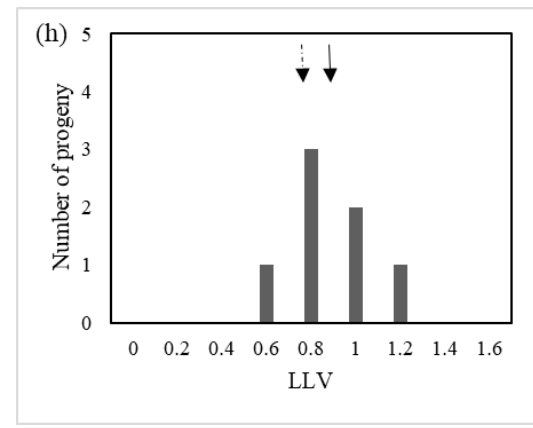
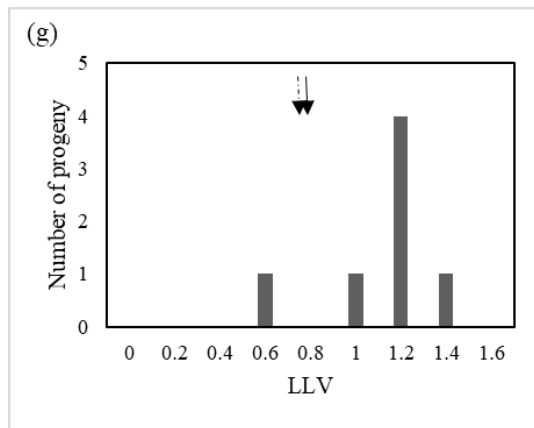
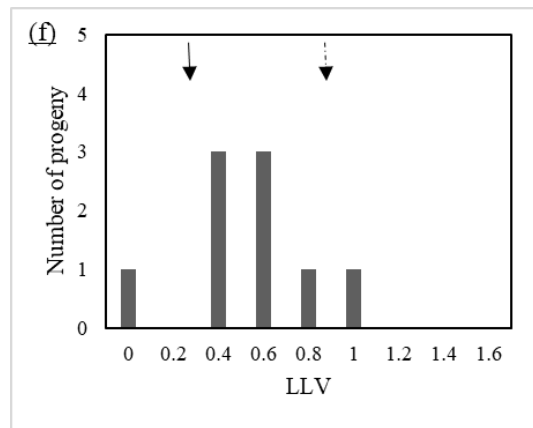
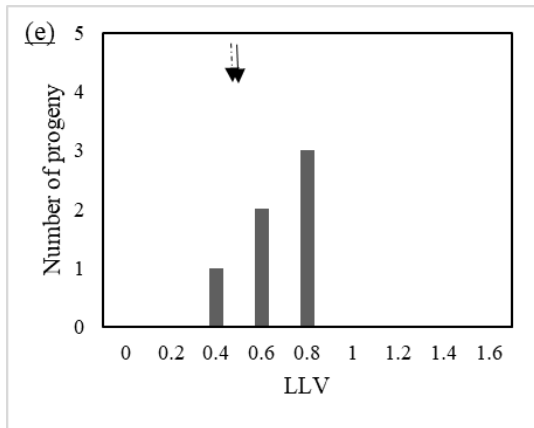

Fig. 3-7. e-j (continued)

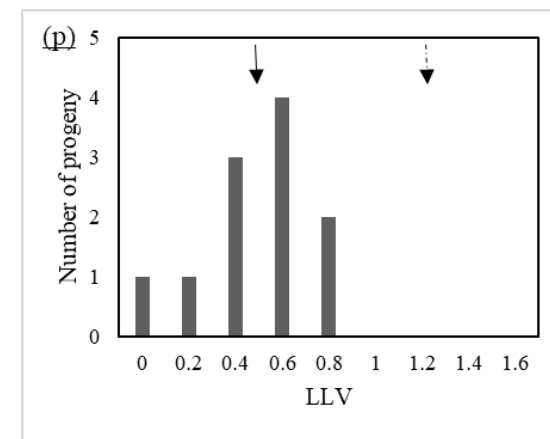
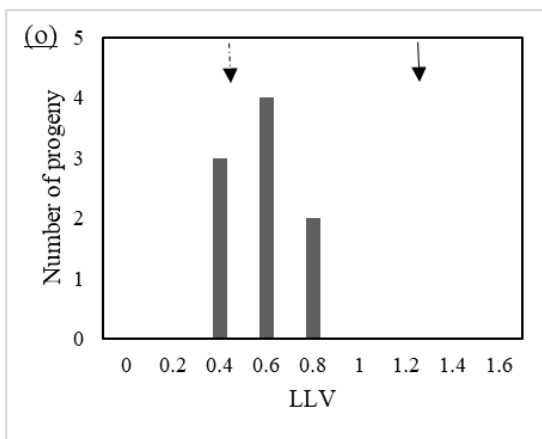
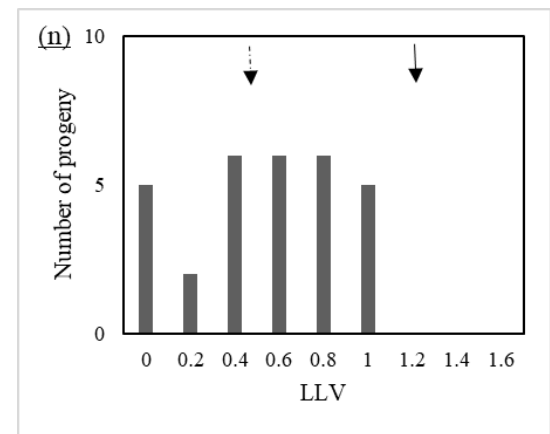
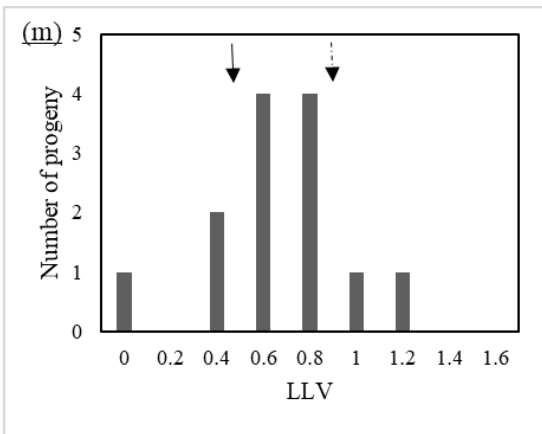
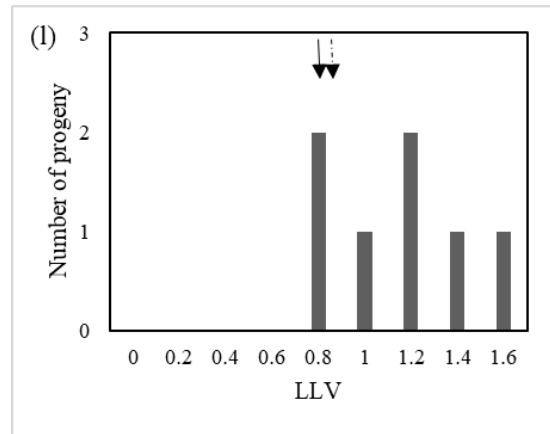
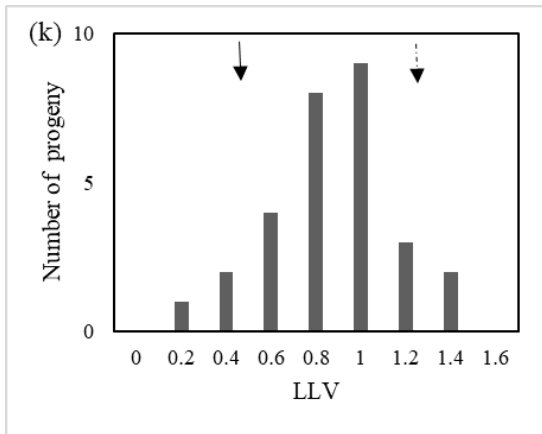

Fig. 3-7. k-p (continued)

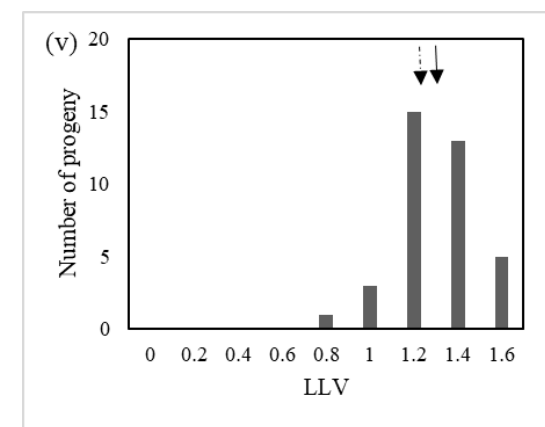
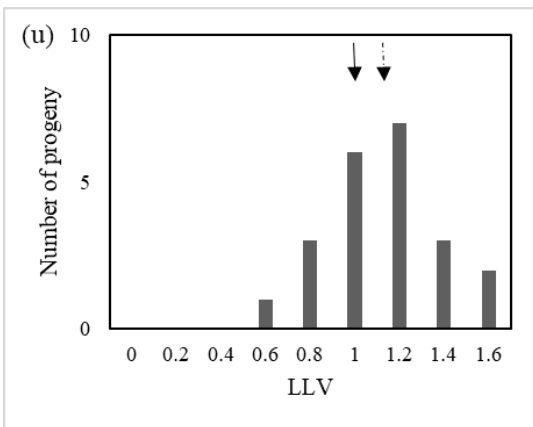
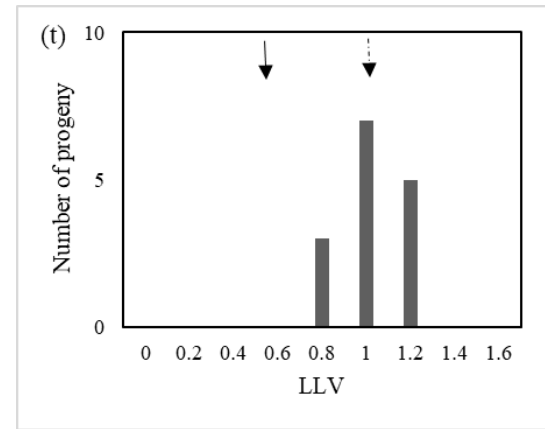
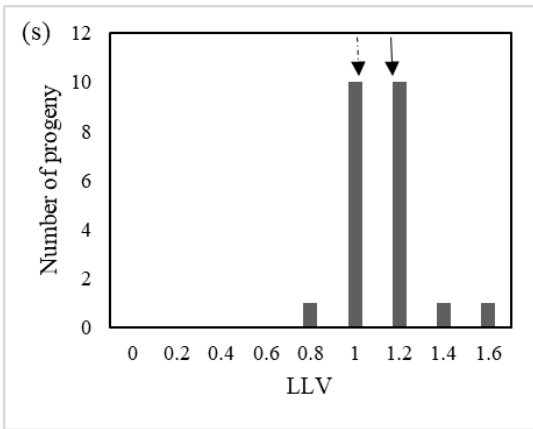
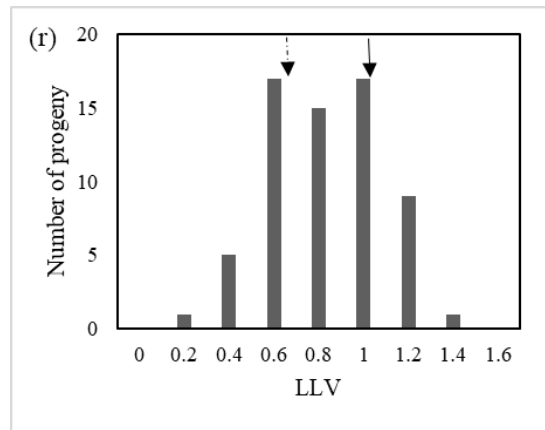
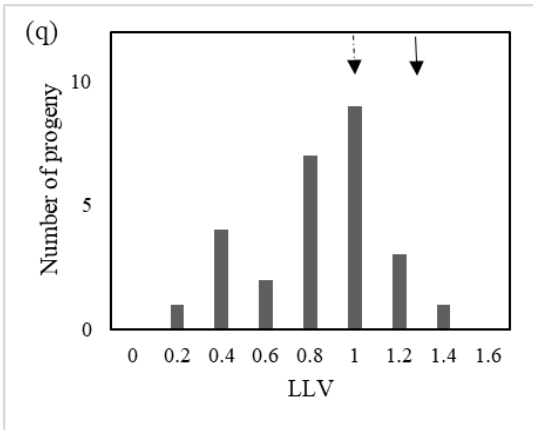

Fig. 3-7. q-v (continued)

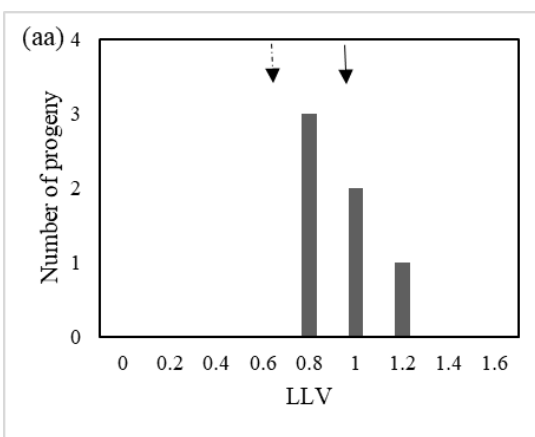
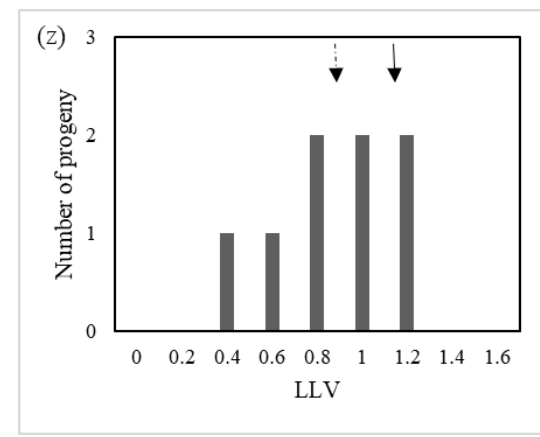
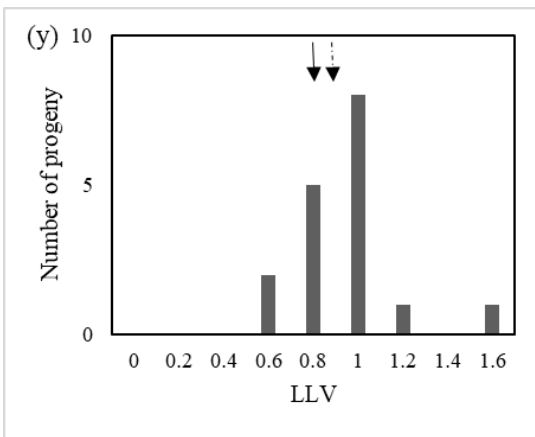
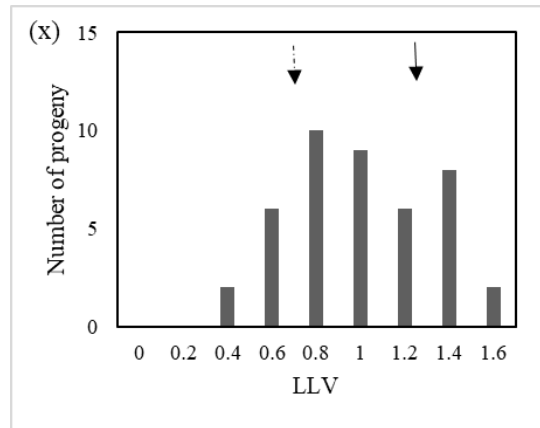
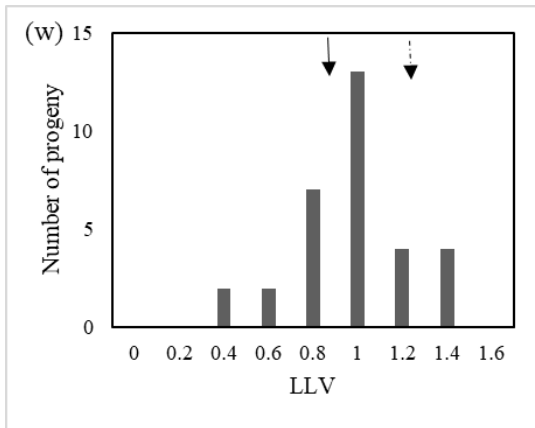

Fig. 3-7. w-aa (continued)

Chapter 4

General discussion

In *Chapter 2*, I developed a method for artificial inoculation of bacterial spot and clarified the differences in lesion expansion in many peach cultivars and selections. ANOVA of data of 25 cultivars tested repeatedly from 2006 to 2008 showed that the effect of genotype but not year was significant. Six cultivars or selections were used to optimize inoculum concentration and inoculation time, and inoculation at 10^8 cfu·mL⁻¹ in June was found to be optimal in Tsukuba. In 69 cultivars/selections evaluated for 2 years, LLVs ranged from 0.476 for ‘Chimarrita’ to 1.606 for ‘Nakatsu Hakutou’. No relationship was found between LLV and flesh color. The relationship between the region of origin and resistance was not clear. Susceptibility did not seem to change with time of release of cultivars, suggesting the lack of selection for bacterial spot resistance in peach breeding in Japan. Some of the 69 cultivars/selections were moderately resistant: two canning peaches ‘Nishiki’ and ‘Mochizuki’ and the foreign cultivars ‘Harson’ and ‘Chimarrita’. These cultivars are considered not suitable for table consumption in Japan (Table 4-1), but they could be crossed with Japanese table peach cultivars/selections with high eating quality with the aim of combining the resistance to bacterial spot with fruit quality. Notably, ‘Tsukikagami’, a table peach cultivar, was relatively resistant and may be a useful cross parent.

In *Chapter 3*, I used 28 cross parents and a population of 514 offspring from a breeding program at NIFTS and found that resistance derived from Brazilian cultivars, including ‘Chimarrita’, is controlled by a QTL with a large effect, whereas another type of resistance is controlled by several QTLs with small effects. The resistance of Japanese peaches ‘Mochizuki’ and ‘Tsukikagami’ may be of the latter type. The mean LLVs of progeny from

crosses between Brazilian cultivars/selections having low LLVs and cultivars/selections having high LLVs were low and close to those of Brazilian parents. I estimated that offspring with low LLVs will rarely be obtained from crosses between Japanese cultivars/selections, but Brazilian cultivars/selections with low LLVs can be used for this purpose. Elucidation of the mode of resistance of inheritance will be useful in accelerating breeding for resistance to bacterial spot in peaches.

Resistant cultivars are required because complete control of bacterial spot by chemical application is difficult; however, no qualitatively resistant cultivars are grown in Japan and no breeding for resistance has been carried out until recently. NIFTS has started breeding for bacterial spot resistance as one of its breeding objectives. The aims of this study were to establish an artificial inoculation method to evaluate susceptibility of multiple cultivars/selections, to select parents available for resistance breeding, and to analyze the inheritance of resistance using a seedling population.

To evaluate susceptibility, artificial inoculation by wounding shoots and leaves with needles and introducing a bacterial inoculum have been used for black spot of plum (Miyake *et al.*, 1999), citrus bacterial canker (Shiotani *et al.*, 2000), and loquat canker (Hiehata *et al.*, 2007). The inoculation method was modified for black spot of plum reported by Miyake *et al.* (1999).

Xanthomonas bacteria cause rice leaf blight (*X. oryzae* pv. *oryzae*; Ezuka and Kaku, 2000), citrus canker (*X. citri* subsp. *citri*; Shiotani, 2010), and black rot of crucifers (*X. campestris* pv. *campestris*; Williams, 1980), which are among the most destructive diseases of these crops, entering the host plants through pores and wounds (Tabei and Mukoo, 1960; Koizumi, 1977; Williams, 1980). Inoculation tests are conducted by wounding and injecting bacteria with a needle or by clipping injection in rice (Ezuka and Kaku, 2000), and by needle injection in citrus (Koizumi, 1977) and crucifers (Inoue and Azegami, 2013). The causal

bacteria of rice leaf blight have been divided into seven races according to pathogenicity against seven rice variety groups in Japan (Kaku and Ochiai, 1996). Strains of *X. citri* subsp. *citri* were divided into strongly and weakly aggressive on the basis of bacterial growth in planta and lesion expansion after prick inoculation of *Citrus grandis* ‘Otachibana’ (Shiotani *et al.*, 2000). Vicente *et al.* (2001) grouped 144 isolates of *X. campestris* pv. *campestris* into six races on the basis of reaction of differential cultivars and reported races 1 and 4 as predominant.

After the breakdown of bacterial blight resistance of ‘Asakaze’, which had been released as a resistant rice cultivar, classification of pathogenicity of bacterial races against rice cultivars has been modified (Kaku and Ochiai, 1996). Around 40 genes conferring resistance to various strains of *X. oryzae* pv. *oryzae* have been identified from cultivated rice and wild rice species (Bhasin *et al.*, 2012); several have been physically mapped or cloned (Suh *et al.*, 2013). Resistance conferred by multiple *R* genes (horizontal resistance) is durable, unlike resistance conferred by a single *R* gene (Gnanamanickam *et al.*, 1999). Pyramiding the resistance genes Xa4, xa5, and Xa21 provided a higher resistance to *X. oryzae* pv. *oryzae* than the introduction of the individual resistance genes (Suh *et al.*, 2013).

Some examples on other plant diseases caused by *Xanthomonas* can lead to show a breeding strategy resistant for peach bacterial spot. A different resistant/ susceptible reaction of *Citrus* species against *Xanthomonas* bacterium suggests the possibility to introgress resistance from closely related species. Furthermore, resistant breeding approach on rice bacterial blight caused by *Xanthomonas* suggests that pyramiding the resistance genes is important for accumulation of resistance. Because peach has several closely related species which can be crossed with peach, introgression of resistant to bacterial spot from closely related species may be a good approach to obtain resistance to bacterial spot.

Resistance is typically recognized as being either qualitative or quantitative (Nelson *et*

al., 2018). These terms are used to distinguish both the phenotypic expression of resistance and the type of inheritance typically associated with each, but there are cases that are not readily classified into qualitative and quantitative (Niks *et al.*, 2015). Resistance that is quantitative according to its phenotypic nature may have a qualitative inheritance and vice versa (Niks *et al.*, 2015). In *Chapter 2*, resistance to peach bacterial spot evaluated by inoculation into shoots was quantitative. In *Chapter 3*, resistance derived from Brazilian cultivars had qualitative inheritance controlled by a QTL with a large effect, whereas resistance derived from Japanese cultivars was quantitative.

In *Chapter 2*, I developed an artificial inoculation method, evaluated a number of cultivars/selections, and selected a parent candidate for crossing. In *Chapter 3*, our analysis of an offspring population indicated the presence of a QTL with a large effect derived from ‘Chimarrita’ and ‘Coral’ from Brazil. These results suggest potential strategies to efficiently advance breeding for resistance to peach bacterial spot. The large-effect QTL will enable breeding of seedlings with high resistance similar to that of the highly resistant parent. The feasibility of breeding of peach cultivars with high fruit quality using cultivars introduced from Brazil is confirmed by the production of ‘Sakuhime’, which combines high fruit quality and low chilling requirement derived from ‘Coral’ (Yaegaki *et al.*, 2017) (Figs. 4-1, 4-2).

‘Coral’ and ‘Chimarrita’ were introduced into Japan in 1971 and 1989, respectively, and have been used as genetic resources for introducing low chilling requirement in Japanese peach breeding programs (Yaegaki *et al.*, 2017; Sawamura *et al.*, 2017). In the Japanese climate, poor fruit quality includes an unpleasant flavor and unattractive appearance such as greenish ground color. ‘Sakuhime’ (formerly Momo Tsukuba 127), which has been recently released (Yaegaki *et al.*, 2017), has high fruit quality, large fruit size, and a low chilling requirement (Sawamura *et al.*, 2017); the release of this cultivar required three plant generations (Figs. 4-1, 4-2). Sherman and Lyrene (1981) suggested that there is no

relationship between the chilling requirement and the degree of susceptibility to bacterial spot. That suggestion is consistent with the fact that ‘Sakuhime’ has a low chilling requirement and high susceptibility to bacterial spot. Thus, new cultivars such as ‘Sakuhime’ with excellent fruit quality could be developed by repeated crossing over a few generations among Brazilian and Japanese cultivars/selections.

Using an F2 population of 63 peach genotypes derived from a cross between susceptible ‘O’Henry’ and resistant ‘Clayton’, Yang *et al.* (2013) constructed a linkage map. They collected phenotypic data for leaf and fruit response to *X. arboricola* pv. *pruni* infection over 3 years at two locations and detected 14 QTLs involved in bacterial spot resistance. Gasic *et al.* (2015) validated that contrasting alleles for resistance levels at two major-effect QTLs (Xap.Pp.OC-1.2 and Xap.Pp.OC-6.1) for peach fruit response to bacterial spot infection are present in U.S. peach breeding germplasm. High-resolution genome scans of this germplasm conducted within the RosBREED project were associated with phenotypic data on fruit bacterial spot resistance to determine effects and distributions of functional alleles, and the authors claimed that alleles conferring resistance are present in many cultivars, but alleles for susceptibility are much more common.

Yamamoto and Terakami (2016) outlined progress of genomic research on pear and other Rosaceae fruit trees, such as whole-genome sequences, genome-wide SNP and SSR markers, construction of reference genetic linkage maps, and synteny studies. Whole-genome sequences have been reported for peach (Verde *et al.*, 2013). A large number of SSR markers have been developed for peach (Dirlewanger *et al.*, 2002; Howad *et al.*, 2005; Nishitani *et al.*, 2007). Using next-generation sequencing technology, the International Peach SNP Consortium has re-sequenced the whole genomes of 56 peach breeding accessions (Verde *et al.*, 2012, 2013) and developed a 9K SNP array (Verde *et al.*, 2012). Using the GoldenGate assay, Martínez-García *et al.* (2013) have evaluated a set of 1536 SNPs of peach developed

from the whole-genome sequences of three cultivars. The genomic information will help us to develop new cultivars with desirable traits by MAS and new genomic-based strategies in breeding programs (Yamamoto and Terakami, 2016).

The large size of fruit trees limits the number of seedlings that can be planted in selection fields, thereby hindering tree fruit breeding. DNA marker-assisted selection has been developed in many woody fruit crops (Luby and Shaw, 2001). Such selection enables breeders to increase considerably the number of seedlings and select them before planting in a selection field because marker-assisted selection can be applied to very young small plants. DNA markers associated with the resistance gene present in the Brazilian cultivars/selections will be developed through DNA marker mapping and QTL analysis in future studies. In conclusion, the information obtained in this study will open the windows to breeding new attractive peach cultivars, by the use of DNA markers linked to the interest traits, statistical genetic analysis, and whole genome information.

Table 4-1. Fruit characteristics of relatively resistant and susceptible cultivars.

Cultivar	LLV	Harvest time	Fruit weight (g)	Soluble solids concentration (%)	Acidity (pH)
Mochizuki	0.51	August-18	251	12.0	4.29
Tsukikagami	0.67	August-18	366	13.7	4.30
Coral		September-18	186	12.8	4.36
Chimarrita	0.48	August-18	288	12.3	4.22
<hr style="border-top: 1px dashed black;"/>					
Akatsuki	0.88	July-18	337	16.5	4.53
Sakuhime	0.92	June-18	253	12.8	4.62

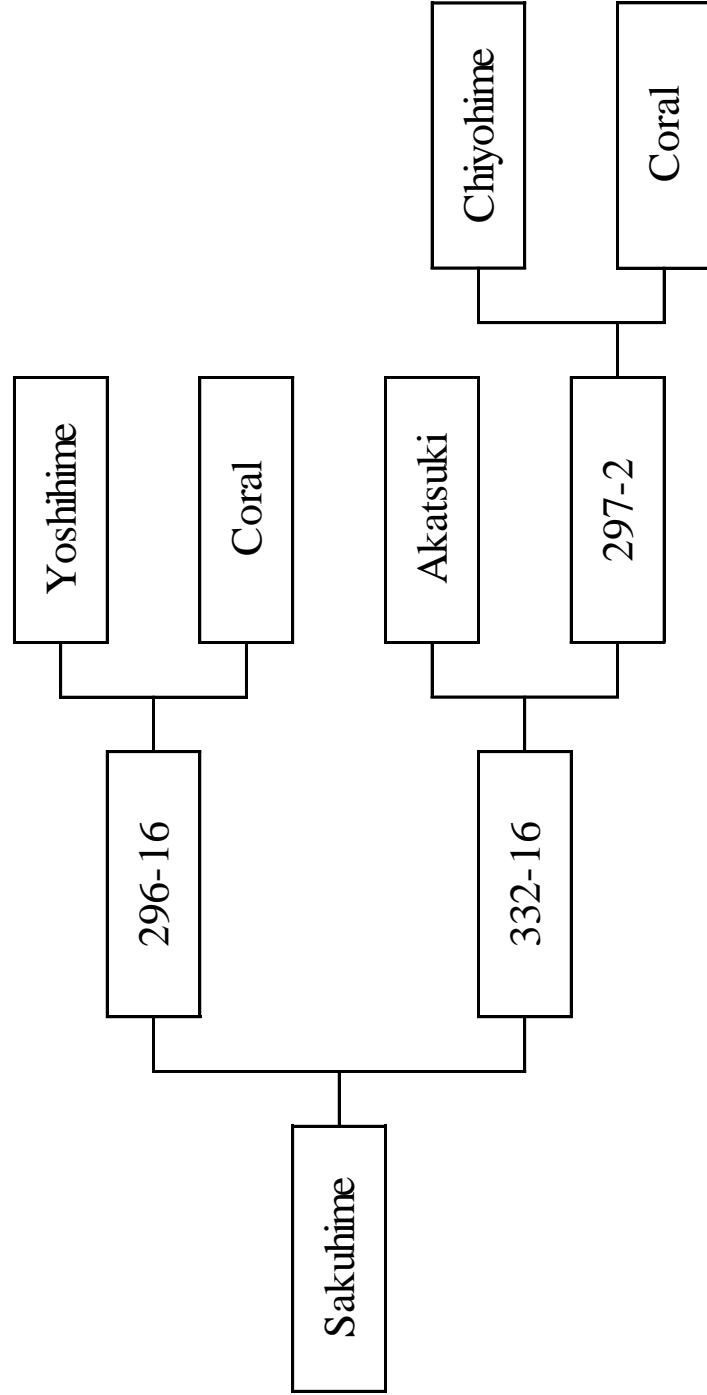

Fig. 4-1. Pedigree of 'Sakuhime'.



Fig. 4-2. Fruit of 'Sakuhime'. (Photographed by NIFTS)

Acknowledgements

I wish to express my grateful thanks to Dr. T. Yamamoto (Professor at the Graduate School of Life and Environmental Science, University of Tsukuba) for his continuous encouragement, persistent guidance, and invaluable suggestions.

Thanks are also due to Professors of the Graduate School of Life and Environmental Science (University of Tsukuba) Drs. T. Moriguchi, T. Hayashi, S. Sugaya, M. Kuniyama and H. Iketani (Professor at the Faculty of Biosphere-Geosphere Science, Okayama University of Science) for their guidance, valuable comments, and critical review to further improve my dissertation.

I am grateful to Dr. M. Yamada for his continuous supervision and kindly advise on the statistical method of this work.

I deeply thank Dr. H. Yaegaki, Dr. M. Yamaguchi, Dr. Y. Sawamura, Mr. E. Adachi, Dr. T. Yamane for their valuable suggestions and discussions. I also thank Ms. F. Nakane, Ms. J. Tanaka, and Ms. M. Kamiyama for their technical assistance.

References

- Bhasin, H., D. Bhatia, S. Raghuvanshi, J. S. Lore, G. K. Sahi, B. Kaur, Y. Vikal and K. Singh. 2012. New PCR-based sequence-tagged site marker for bacterial blight resistance gene Xa38 of rice. *Mol. Breeding* 30: 607–611.
- Byrne, D. H., M. B. Raseira, D. Bassi, M. C. Piagnani, K. Gasic, G. L. Reihard, M. A. Moreno and S. Perez. 2012. Chapter 14 Peach Fruit breeding, *Handbook of Plant Breeding* 8. M. L. Badenes and D. H. Byrne (eds.) DOI 10.1007/978-1-4419-0763-9_14.
- Campbell, R. C. 1974. *Statistics for biologists*, 2nd Ed. Baifukan, Tokyo.
- Clayton, C. N. 1976. Bacterial spot resistance in stone fruits. *Fruit Var. J.* 30: 15–16.
- Cochran, W. G. 1964. Approximate significance levels of the Behrens-Fisher test. *Biometrics* 20: 191–195.
- Dirlewanger, E., P. Cosson, M. Tavaud, M. J. Aranzana, C. Poizat, A. Zanetto, P. Arús and F. Laigret. 2002. Development of microsatellite markers in peach [*Prunus persica* (L.) Batsch] and their use in genetic diversity analysis in peach and sweet cherry (*Prunus avium* L.) *Theor. Appl. Genet.* 105: 127–138.
- Du Plessis, H. J. 1988. Differential virulence of *Xanthomonas campestris* pv. *pruni* to peach, plum and apricot cultivars. *Phytopathology* 78: 1312–1315.
- Dunegan, J. C. 1932. The bacterial spot disease of the peach and other stone fruits. *Tech. Bull. US Department Agri.* 273: 55
- EPPO. 2018. EPPO Global Database. <<https://gd.eppo.int>>
- EPPO. 2017. *Xanthomonas arboricola* pv. *pruni* (XANTPR). EPPO Global Database. <<https://gd.eppo.int>>
- Ezuka, A. and H. Kaku. 2000. A historical review of bacterial blight of rice. *Bull. Natl. Inst. Agrobiol. Resour.* 15: 1–207.
- FAO. 2016. FAOSTAT. <<http://www.fao.org/faostat/en/#data/QC>>

- Gasic, K., G. Reihard, W. Okie, J. Clark, T. Gradziel, D. Byrne, C. Peace, T. Stegmeir, U. Rosyara and A. Iezzoni. 2015. Bacterial spot resistance in peach: functional allele distribution in breeding germplasm. *Acta Hort.* 1084: 69–74.
- Gnanamanickam, G. G., V. B. Priyadarisini, N. N. Narayanan, P. Vasudevan and S. Kavitha. 1999. An overview of bacterial blight disease of rice and strategies for its management. *Current Sci.* 77: 1435–1443.
- Hiehata, N., S. Fukuda and O. Terai. 2007. Evaluation of loquat canker resistance in new loquat cultivars released in Japan and introduced from foreign countries. *Bull. Nagasaki Fruit Tree Exp. Stn.* 10: 14–21.
- Howad, W., T. Yamamoto, E. Dirlewanger, R. Testlin, P. Cosson, G. Cipriani, A. J. Monforte, L. Georgi, A. G. Abbott and P. Arús. 2005. Mapping with a few plants: Using selective mapping for microsatellite saturation of the *Prunus* reference map. *Genetics* 171: 1305–1309.
- Inoue, Y. and K. Azegami. 2013. *Xanthomonas campestris* pv. *campestris*, causal agent of black rot of crucifer, and bacteriophages which lyse it. MAFF Microorganism Genetic Resources Manual No. 34. (In Japanese)
- Kajiura, M., K. Kanato, A. Kurihara, M. Yoshida, K. Matsuda, T. Sato and R. Harada. 1966. New canning peach variety ‘Nishiki’. *Bull. Hort. Res. Sta. A, Hiratsuka* 5: 131–138. (In Japanese with English summary)
- Kaku, H. and H. Ochiai. 1996. *Xanthomonas oryzae* pv. *oryzae*, causal agent of bacterial leaf blight of rice. MAFF Microorganism Genetic Resources Manual No. 1. (In Japanese)
- Keil, H. L. and H. W. Fogle. 1974. Orchard susceptibility of some apricot, peach and plum cultivars and selections to *Xanthomonas pruni*. *Fruit Var. J.* 28: 16–19.
- Koizumi, M. 1977. Behavior of *Xanthomonas citri* (Hasse) Dowson and histological changes of diseased tissues in the process of lesion extension. *Ann. Phytopathol. Soc. Japan* 43:

- 129-136. (In Japanese with English abstract)
- Kuraoka, E. and S. Kato. 1955. Experiment of bacterial spot of peach. *Fruit Tree Exp. Rep.* A., Shizuoka 312–314. (In Japanese)
- Kuwatsuka, K. 1919. Some studies on peach bacterial shot hole. *Byochugai Zasshi*. 6: 358–363 (In Japanese).
- Kuwatsuka, K. 1921. Some studies on the *Pseudomonas pruni* E. F. Smith. *Ann. Phytopath. Soc. Japan* 1: 12–18.
- Luby, J. J. and D. V. Shaw. 2001. Does marker-assisted selection make dollars and sense in a fruit breeding program? *HortScience* 36: 872–879.
- Martinez-Garcia, P. J., D. E. Parfitt, E. A. Ogundiwin, J. Fass, H. M. Chan, R. Ahmad, S. Lurie, A. Dandekar, T. M. Gradziel and C. H. Crisosto. 2013. High density SNP mapping and QTL analysis for fruit quality characteristics in peach (*Prunus persica* L.). *Tree Genet. Genomes* 9: 19–36.
- Martins, O. M. and M. C. B. Raseira. 1996. Sources of bacterial spot resistance in plum cultivars. *Fruit Var. J.* 50: 156–159.
- Medeiros, J. G. S., I. Citadin, I. dos Santos and A. P. Assmann. 2011. Reaction of peach to genotypes to bacterial leaf spot caused by *Xanthomonas arboricola* pv. *pruni*. *Sci. Agric. (Piracicaba, Braz.)* 68: 57–61.
- Ministry of Agriculture and Forestry. 1974. Survey on fruit production. (In Japanese)
- Ministry of Agriculture, Forestry and Fisheries (MAFF). 1982. Survey on fruit production. (In Japanese)
- Ministry of Agriculture, Forestry and Fisheries (MAFF). 1986. Survey on fruit production. (In Japanese)
- Ministry of Agriculture, Forestry and Fisheries (MAFF). 1995. Survey on fruit production. (In Japanese)

- Ministry of Agriculture, Forestry and Fisheries (MAFF). 2000. Survey on fruit production.
(In Japanese)
- Ministry of Agriculture, Forestry and Fisheries (MAFF). 2005. Agricultural statistics.
<http://www.maff.go.jp/j/tokei/kouhyou/tokusan_kazyu/> (In Japanese)
- Ministry of Agriculture, Forestry and Fisheries (MAFF). 2010. Agricultural statistics.
<http://www.maff.go.jp/j/tokei/kouhyou/tokusan_kazyu/> (In Japanese)
- Ministry of Agriculture, Forestry and Fisheries (MAFF). 2018. Agricultural statistics.
<http://www.maff.go.jp/j/tokei/kouhyou/tokusan_kazyu/> (In Japanese)
- Ministry of Agriculture, Forestry and Fisheries (MAFF). 2018. Agricultural report.
<http://www.maff.go.jp/j/syouan/syokubo/gaicyu/syokubo_nenpo.html> (In Japanese)
- Ministry of Agriculture, Forestry and Fisheries (MAFF). 2018. Agricultural report.
<http://www.maff.go.jp/j/syouan/syokubo/boujyo/120104_yoho.html> (In Japanese)
- Miyake, M., H. Yaegaki, T. Haji and M. Yamaguchi. 1999. Screening of resistance to bacterial spot caused by *Xanthomonas campestris* pv. *pruni* among Japanese plum (*Prunus salicina* Lindl.) and several *Prunus* species by artificial inoculation on shoots. Bull. Natl. Inst. Fruit Tree Sci. 33: 77–96 (In Japanese with English abstract).
- Nelson, R., T. Wiesner-Hanks, R. Wisser and P. Balint-Kurti. 2018. Navigating complexity to breed disease-resistant crops. Nature Reviews 19: 21–33.
- Niks, R. E., X. Qi and T. C. Marcel. 2015. Quantitative resistance to biotrophic filamentous plant pathogens: concepts, misconceptions, and mechanisms. Ann. Rev. Phytopathology 53: 445–470.
- Nishitani, C., T. Kimura, E. Ueda, W. Howad, P. Arús and T. Yamamoto. 2007. Tri-/hexanucleotide microsatellite markers in peach derived from enriched genomic libraries and their application in Rosaceae. Breed. Sci. 57: 289–296.
- Okie, W. R., T. Bacon and D. Bassi. 2008. Fresh market cultivar development. In: Layne, D.

- R. and D. Bassi (eds.) The Peach: Botany, Production and Uses. CABI, Cambridge, pp. 139–174.
- OEPP/EPPO. 2006. OEPP/EPPO Diagnostics *Xanthomonas arboricola* pv. *pruni*. EPPO Bulletin. 36: 129–133.
- Plant Protection Act. 1950. Prevalence Reconnaissance Business by the National Government. Act No. 151 of May 4, Article 23.
- Randhawa, P. S. and E. L. Civerolo. 1985. A detached leaf bioassay for *Xanthomonas campestris* pv. *pruni*. Phytopathology 75: 1060–1063.
- Raseira, M. C. B. and H. Bonifacio. 2006. Peach breeding program in southern Brazil. Acta Hort. 713: 93–97.
- Sakaguchi, S. 1967. Linkage studies on the resistance to bacterial leaf blight, *Xanthomonas oryzae* (Uyeda et Ishiyama) DOWSON, in rice. Bull. Natl. Inst. Agr. Sci. Ser. D16, 1–18 (in Japanese with English summary).
- Sato, A., M. Yamada and H. Iwanami. 2006. Estimation of the proportion of offspring having genetically crispy flesh in grape breeding. J. Amer. Soc. Hort. Sci. 131: 46–52.
- Sawamura, Y., Y. Suesada, T. Sugiura and H. Yaegaki. 2017. Chilling requirements and blooming dates of leading peach cultivars and a promising early maturing peach selection, Momo Tsukuba 127. Hort. J. 86: 426–436.
- Shiotani, H., K. Ozaki and S. Tsuyumu. 2000. Pathogenic interactions between *Xanthomonas axonopodis* pv. *citri* and cultivars of pummelo (*Citrus grandis*). Phytopathology 90: 1383–1389.
- Shiotani, H. 2010. Causal agent of citrus canker, *Xanthomonas citri* subsp. *citri*. MAFF Microorganism Genetic Resources Manual No. 29. (In Japanese)
- Scorza R., S. A. Mehlenbacher and G. W. Lightner. 1985. Inbreeding and coancestry of freestone peach cultivars of the eastern United States and implications for peach

- germplasm improvement. J. Amer. Soc. Hort. Sci. 110: 547–552.
- Sherman, W. B. and P. M. Lyrene. 1981. Bacterial spot susceptibility in low chilling peaches. Fruit Var. J. 35: 74–77.
- Shiina, T., T. Shoji and S. Suzuki. 1966. Studies on the resistance of peach varieties to the infection of bacterial spot, *Xanthomonas pruni* (E. F. Smith) Dowson, in the sand hill of Shonai district. Bull. Yamagata Agri. Exp. Sta. 1: 99–101. (In Japanese)
- Smith, E. F. 1903. Observation on a hitherto unreported bacterial disease, the cause of which enters the plant through ordinary stomata. Science 17: 456–457.
- Snedecor, G. W. and W. G. Cochran. 1972. Statistical methods, 6th ed. Iwanami-shoten, Tokyo.
- Suesada, Y., M. Yamada, T. Yamane, E. Adachi, H. Yaegaki and M. Yamaguchi. 2013. Varietal differences in susceptibility to bacterial spot (*Xanthomonas arboricola* pv. *pruni*) among 69 peach cultivars and selections as evaluated by artificial inoculation to shoots. J. Japan. Soc. Hort. Sci. 82: 293–300.
- Suh, J. P., J. U. Jeung, T. H. Noh, Y. C. Cho, S. H. Park, H. S. Park, M. S. Shin, C. K. Kim and K. K. Jena. 2013. Development of breeding lines with three pyramided resistance genes that confer broad-spectrum bacterial blight resistance and their molecular analysis in rice. Rice 6: 5. DOI: 10.1186/1939-8433-6-5
- Tabei, H. and H. Mukoo. 1960. Anatomical studies of rice plant leaves affected with bacterial leaf blight, in particular reference to the structure of water exudation system. Bull. Nat. Inst. Agri. Sci. Ser. C, Plant Pathology Entomology. 11: 37–44. (In Japanese with English summary).
- Takanashi, K. 1978. Ecological studies on bacterial spot caused by *Xanthomonas pruni* (E. F. Smith) Dowson. Bull. Fruit Tree Res. Sta. A5: 1–71. (In Japanese with English summary)

- Takanashi, K. 1985. Two newly found pathogenic bacteria of peach bacterial shot-hole. Bull. Fruit Tree Res. Sta. A 12: 101–114. (In Japanese with English summary)
- Topp, B. L., W. B. Sherman and R. E. Stall. 1991. Comparison of rating methods for bacterial spot resistance in Japanese-type plum. Fruit Var. J. 45: 70–74.
- Topp, B. L. and W. B. Sherman. 1995. Plum bacterial spot resistance in leaves and stems measured by a selection index. Acta Hort. 403: 47–50.
- Verde, I., A. G. Abbott, S. Scalabrin, S. Jung, S. Shu, F. Marroni, T. Zhebentyayeva, M. T. Dettori, J. Grimwood, F. Cattonaro, A. Zuccolo, L. Rossini, J. Jenkins, E. Vendramin, L. A. Meisel, V. Decroocq, B. Sosinski, S. Prochnik, T. Mitros, A. Policriti, G. Cipriani, L. Dondini, S. Ficklin, D. M. Goodstein, P. Xuan, C. Del Fabbro, V. Aramini, D. Copetti, S. Gonzalez, D. S. Horner, R. Falchi, S. Lucas, E. Mica, J. Maldonado, B. Lazzari, D. Bielenberg, R. Pirona, M. Miculan, A. Barakat, R. Testolin, A. Stella, S. Tartarini, P. Tonutti, P. Arús, A. Orellana, C. Wells, D. Main, G. Vizzotto, H. Silva, F. Salamini, J. Schmutz, M. Morgante and D. S. Rokhsar. 2013. The high-quality draft genome of peach (*Prunus persica*) identifies unique patterns of genetic diversity, domestication and genome evolution. Nat. Genet. 45: 487–494.
- Verde, I., N. Bassil, S. Scalabrin, B. Gilmore, C. T. Lawley, K. Gasic, D. Micheletti, U. R. Rosyara, F. Cattonaro, E. Vendramin, D. Main, V. Aramini, A. L. Blas, T. C. Mockler, D. W. Bryant, L. Wilhelm, M. Troggio, B. Sosinski, M. J. Aranzana, P. Arús, A. Iezzoni, M. Morgante and C. Peace. 2012. Development and evaluation of a 9K SNP array for peach by internationally coordinated SNP detection and validation in breeding germplasm. PLoS ONE 7: e35668. DOI: 10.1371/journal.pone.0035668
- Vicente, J. G. J. Conway, S. J. Roberts and J. D. Taylor. 2001. Identification and origin of *Xanthomonas campestris* pv. *campestris* races and related pathovars. Phytopathology 91: 492–499.

- Werner, D. J., D. F. Ritchie, D. W. Cain and E. I. Zehr. 1986. Susceptibility of peaches and nectarines, plant introductions, and other *Prunus* species to bacterial spot. HortScience 21: 127–130.
- Williams, P. H. 1980. Black rot: A continue threat to world crucifers. Plant Disease 64: 736–742.
- Yaegaki, H., M. Yamaguchi, T. Haji, Y. Suesada, H. Kyotani, K. Nishimura, M. Miyake, E. Adachi, T. Yamane, T. Kozono, H. Fukuda, T. Kihara, K. Suzuki and M. Uchida. 2016. New peach cultivar ‘Tsukikagami’. Bull. NARO Inst. Fruit Tree Sci. 21: 1–9.
- Yaegaki, H., Y. Suesada, Y. Sawamura, T. Haji, E. Adachi, T. Yamane and M. Yamaguchi. 2017. New peach cultivar ‘Sakuhime’. Hort. Res. 16 (S2): 376.
- Yamada, M. 2011. Cross breeding in woody fruit crops. (In Japanese). Yokendo.
- Yamada, M., H. Yamane and Y. Ukai. 1995. Genetic analysis of fruit ripening time in Japanese persimmon. J. Amer. Soc. Hort. Sci. 120: 886–90.
- Yamada, M., H. Yamane, Y. Takano and Y. Ukai. 1997. Estimation of the proportion of offspring having soluble solids content in fruit exceeding a given critical value in Japanese persimmon. Euphytica 93: 119–126.
- Yamaguchi, M., H. Kyotani, M. Yoshida, T. Haji, K. Nishimura, Y. Nakamura, M. Miyake, H. Yaegaki, K. Tanaka, Y. Ishikawa, T. Kihara, K. Suzuki, H. Fukuda and T. Asakura. 2001. New canning peach cultivar ‘Mochizuki’ with white flesh. Bull. Natl. Inst. Fruit Tree Sci. 35: 33–45 (In Japanese with English abstract).
- Yamamoto, T., K. Mochida and T. Hayashi. 2003. Shanghai Suimitsuto, one of the origins of Japanese peach cultivars. J. Japan. Soc. Hort. Sci. 72: 116–121.
- Yamamoto, Y., C. Ogaki and Y. Tatsuno. 1953. Experiments and investigations on the bacterial spot of peach. 1) Effects of weather condition on outbreak of the disease, and susceptibility in the varieties of peach. Bull. Kanagawa Agri. Exp. Sta. 1: 57–62 (In

Japanese with English summary).

Yamamoto, T. and S. Terakami. 2016. Genomics of pear and other Rosaceae fruit trees. *Breed.*

Sci. 66: 148–159.

Yang, N., G. Reighard, D. Ritchie, W. Okie and K. Gasic. 2013. Mapping quantitative trait

loci associated with resistance to bacterial spot (*Xanthomonas arboricola* pv. *pruni*) in

peach. *Tree Genet. Genomes* 9: 573–586.