

# Studies of extremely dense matter in heavy-ion collisions at J-PARC

著者 (英)	J-PARC-HI Collaboration, Tatsuya CHUJO, Shinichi ESUMI, Yasuo MIAKE
journal or publication title	Nuclear physics. A
volume	982
page range	959-962
year	2019-02
権利	(C) 2018 Published by Elsevier B.V. This is an open access article under the CC BY-NC-ND license ( <a href="http://creativecommons.org/licenses/by-nc-nd/4.0/">http://creativecommons.org/licenses/by-nc-nd/4.0/</a> ).
URL	<a href="http://hdl.handle.net/2241/00157832">http://hdl.handle.net/2241/00157832</a>

doi: 10.1016/j.nuclphysa.2018.11.027



XXVIIth International Conference on Ultrarelativistic Nucleus-Nucleus Collisions  
(Quark Matter 2018)

# Studies of extremely dense matter in heavy-ion collisions at J-PARC

H. Sako for the J-PARC-HI Collaboration<sup>a,b</sup>

<sup>a</sup>Advanced Science Research Center, Japan Atomic Energy Agency, Ooaza Shirakata 2-4, Tokai, Naka, Ibaraki 319-1195, Japan

<sup>b</sup>Tomonaga Center for the History of the Universe, University of Tsukuba, Tsukuba, Ibaraki 305-8571, Japan

## Abstract

We aim to study extremely dense matter in heavy-ion collisions at 1 – 19 AGeV/c at a future project of J-PARC (J-PARC-HI). We will search for the first order phase boundary and its critical end point in the QCD phase diagram. We also aim at studying the properties of dense matter related to neutron stars and neutron star mergers, in particular the equation of state (EOS). We expect to produce the world's highest rate of  $10^{11}$  Hz of heavy-ion beams, with ion species from p to U. We design spectrometers based on a large dipole magnet to measure hadrons, dimuons, and hypernuclei. We evaluate some of key performance of the spectrometers based on detailed simulations.

### Keywords:

QCD critical point, neutron star, neutron star merger

## 1. Introduction

At high-temperature and low baryon density regime in the QCD phase diagram, QGP has been discovered and its properties have been studied at SPS, RHIC, and LHC. However, the phase transition in this regime is known to be smooth cross-over, according to lattice QCD calculations. On the other hand, at high baryon density regime, rich QCD phase structures such as the first-order phase transition, its critical end point, and color superconducting phases are predicted theoretically. Heavy-ion collisions at  $\sqrt{s_{NN}} = 5 - 10$  GeV could discover those structures. At J-PARC (Japan Proton Accelerator Research Complex), we are developing a future plan with heavy-ion beams at 1 – 19 AGeV/c. We aim at exploring the dense baryonic matter to search for QCD phase structures and to study properties of dense matter such as the EOS that is related to neutron stars and neutron star mergers.

We design the heavy-ion beams at J-PARC-HI [1] with the world's highest beam intensity of  $\sim 10^{11}$  Hz at the beam energy of 1 – 19 AGeV for U ion, corresponding to  $\sqrt{s_{NN}} = 1.9 - 6.2$  GeV. We accelerate various ion species from p to U. We require a heavy-ion injector which consists of a linac and a booster ring. The ion accelerated in the injector is accelerated in the existing Rapid-Cycling Synchrotron (RCS) and the Main Ring synchrotron (MR).

In J-PARC-HI, in addition to conventional centrality cuts, we can select extremely high baryon density events with some observables correlated to the maximum baryon density in the collision. A candidate is the sum of transverse momenta of charged particles, which has correlation according JAM model [2]. Using such observables, if we have more events with J-PARC's very high rate beams, we could reach higher density events. The observables that we will measure are, dileptons, hadrons including event-by-event fluctuations, collective flow, and two particle hyperon-hyperon (YY) and hyperon-nucleon (YN) correlations. In particular we concentrate on properties which require extremely high statistics. For example, dileptons at the mass higher than  $1.2 \text{ GeV}/c^2$ , higher-order fluctuations, and flow. We also search for multi-strangeness systems such as hypernuclei with  $|s| \geq 3$  and strangelets which require high statistics.

Fluctuations of conserved charge is considered as one of the most sensitive probes for the QCD critical point. At RHIC-BES program, the STAR experiment observed non-monotonic dependence of the 4th-order net-proton cumulant as a function of  $\sqrt{s_{NN}}$  with the large enhancement at the lowest energy  $\sqrt{s_{NN}} \sim 7.7 \text{ GeV}$  [3]. At J-PARC-HI, we measure them at  $\sqrt{s_{NN}} \leq 6 \text{ GeV}$  with small statistical uncertainties, which could conclude if the critical point really exists or not. Even higher-order cumulants such as 6th or 8th order could be measured at J-PARC-HI, utilizing extremely high beam rates. With 6th or 8th order cumulants of net baryon numbers, we could distinguish the order of phase transitions even if it is cross-over [4]. 6th or 8th order cumulants require several-order higher statistics compared to 4th order cumulants, but they will be feasible at J-PARC-HI.

Dileptons include various important physics related to phase structures, which require many-order different statistics depending on the invariant mass range. In the low mass region ( $< 1.2 \text{ GeV}/c^2$ ), with the  $4\pi$  yields per event of the dielectron decay of  $\rho$ ,  $\omega$ , and  $\phi$  of  $10^{-5} - 10^{-3}$  in  $10 \text{ AGeV}/c$  Au+Au collisions, we study in-medium changes of mass spectra. With high statistics, we could directly compare the moments of mass spectra with those from QCD sum rules, which could extract quark and gluon condensates [5]. In the intermediate mass region ( $1.2$  to  $3 \text{ GeV}/c^2$ ), the dilepton yield per event in  $10 \text{ AGeV}/c$  Au+Au decreases to  $\sim 10^{-8}$ . Due to low collision energies at J-PARC-HI, charm production is suppressed. Therefore, we could search for thermal radiation from QGP with low background. In high mass region ( $> 3 \text{ GeV}/c^2$ ), we can measure  $J/\Psi$  with the yield per event of  $\sim 10^{-7}$  in  $10 \text{ AGeV}/c$  Au+Au collisions [6], if there is no strong  $J/\Psi$  suppression observed at SPS [7]. We could investigate the onset of the  $J/\Psi$  suppression mechanism.

Observation of a neutron merger event with gravitational waves [8] constrained the EOS of symmetric nuclear matter from tidal deformation of neutron stars estimated from the evolution spectrum of the gravitational wave. Through collective flow measurements, we can also constrain the EOS of dense matter at J-PARC-HI. Such attempt has been done with the JAM model using the slope of the directed flow with the rapidity [9]. Actually, negative slopes were observed in the energy range above  $\sqrt{s_{NN}} = 10 \text{ GeV}$ , which suggests the softening of the EOS possibly due to phase transition.

## 2. Experimental setup and expected performance

We are considering the following scheme for high-rate measurements at J-PARC. We reduce the data rates by the central trigger, and also online triggers for physics observables such as the dimuon trigger. Then, we use continuous triggerless readout of detector signals, and data reduction with online tracking and event selection utilizing a large scale computing system, similar to the systems adopted in ALICE and CBM. We consider a new spectrometer design based on a large dipole magnet with a upgrade scheme as the beam intensity increases. We will first build a hadron spectrometer (up to  $\sim 10^6 \text{ Hz}$ ), and upgrade it to a dimuon spectrometer (up to  $\sim 10^7 \text{ Hz}$ ), and then to a hypernuclear spectrometer (up to  $\sim 10^8 \text{ Hz}$ ), in Hadron Experimental Facility at J-PARC. The time scales of each upgrade depend on the beam intensity development of the accelerator.

The hadron spectrometer is a fixed-target spectrometer, as shown in Figs. 1 and 2. It consists of a large superconducting dipole magnet with the vertical magnetic field, a Time Projection Chamber (TPC), Silicon Pixel Trackers (SPT's) surrounding the target, GEM trackers, and a Time-Of-Flight counter (TOF) consisting of Multi-gap Resistive Plate Chambers (MRPC's). The TPC has a cylindrical hole around the beam axis which corresponds to the polar angle less than  $4^\circ$ , where SPT's will be installed. In this scheme, track reconstruction up to  $10^6 \text{ Hz}$  interaction rate is achievable. The centrality is defined with the correlation

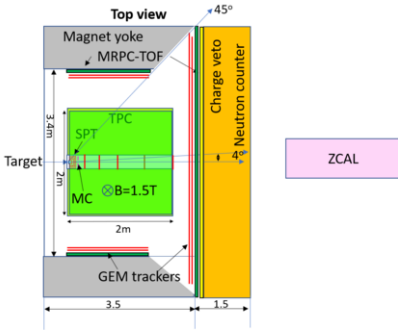

Fig. 1. The top view of the hadron spectrometer.

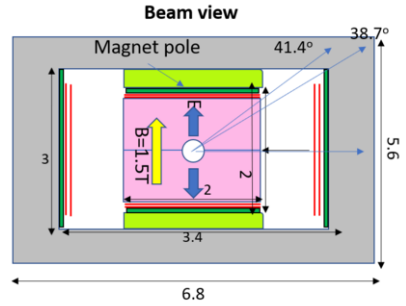

Fig. 2. The beam view of the hadron spectrometer.

between the energy deposit in the Zero-degree CALorimeter (ZCAL) and the Multiplicity Counter (MC) just downstream the target. The acceptance of the spectrometer is more than 80% of  $4\pi$  for  $p$ ,  $K^\pm$ , and  $\pi^\pm$ . The particle identification performance is shown in Fig. 3 with the rigidity ( $p/q$ ) and the mass-squared obtained from the time-of-flight, and also in Fig. 4 with the energy deposit in the TPC and the rigidity. Clear separation of charged hadrons is demonstrated.

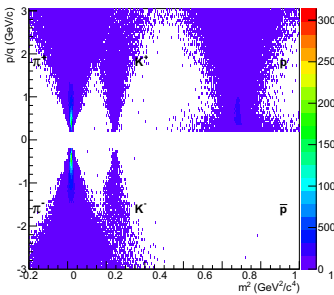

Fig. 3. Rigidity ( $p/q$ ) (GeV/c) vs mass-squared ( $\text{GeV}^2/c^4$ ).

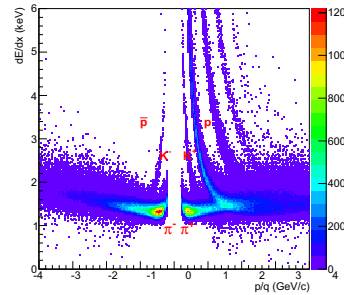

Fig. 4.  $dE/dx$  in TPC vs rigidity (GeV/c).

Fig. 5 shows the dimuon spectrometer, which will be upgraded from the hadron spectrometer. We will upgrade 4 layers of SPT's to 7 layers, and replace the TPC by a muon tracking system consisting of lead hadron absorbers and GEM trackers. The fully simulated and reconstructed dimuon spectrum is shown in Fig. 8, and its generated cocktail spectrum is shown in Fig. 7. We generated cocktail events for 10 AGeV U+U collisions. We embedded them into JAM U+U events as background. The number of the JAM and the cocktail events is 54 thousand, and the number of the dimuon signals in the cocktail is enhanced by factor of 1000. Then, these events were processed in GEANT4 and reconstructed in the tracking code. Cuts used in those spectra are  $\theta_{\mu^+\mu^-} > 2^\circ$ ,  $2^\circ < \theta < 80^\circ$ , and  $p_T > 0.1$  GeV/c, where  $\theta_{\mu^+\mu^-}$  is the opening angle between  $\mu^+$  and  $\mu^-$ , and  $\theta$  and  $p_T$  are the polar angle and the transverse momentum of  $\mu^+$  or  $\mu^-$ . The reconstructed like-sign pair spectrum (blue) is subtracted from the mixed-event like-sign pair spectrum (black) to extract the signal spectrum (red) in Fig. 8. Clear  $\omega$  and  $\phi$  peaks with high mass resolution are shown.

We also designed a spectrometer to measure hypernuclei and to search for strangelets around the beam rapidity as shown in Fig. 6. We introduce an additional sweep magnet in the upstream which bends and stops most of hadrons at the collimator, while letting beam ions and near-neutral fragments enter the main dipole magnet common to the hadron and the dipole spectrometers. In the TPC in the main dipole magnet, hypernuclear decay events are reconstructed. The fragment multiplicity in the TPC should be reduced to  $10^{-1} \sim 10^{-2}$  level by the collimator hole size so that the interaction rate around  $10^8$  Hz can be operated

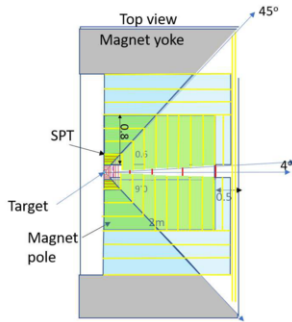

Fig. 5. The top view of the dimuon spectrometer.

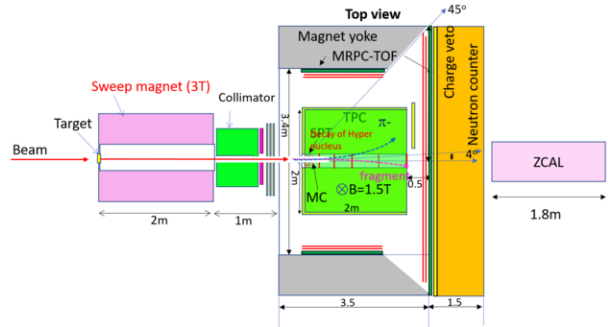

Fig. 6. The top view of the hypernuclear spectrometer.

at the TPC. Various light hypernuclear fragments with small  $N/Z$  with single and multi-strangeness can be searched for. Among them, negative-charged hypernuclei such as  $\Xi n$  and  $\Xi m$  have never been discovered.

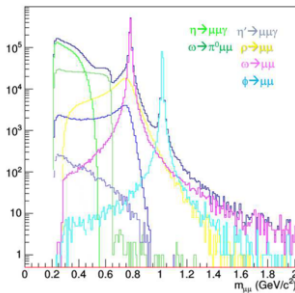

Fig. 7. The cocktail spectrum of dimuons.

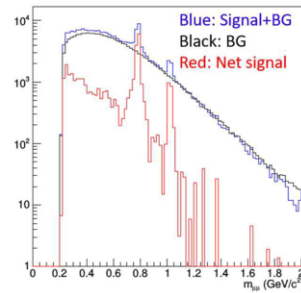

Fig. 8. The fully simulated and reconstructed dimuon spectrum.

### 3. Conclusions

In J-PARC-HI, we designed new spectrometers based on a large dipole magnet, which measure hadrons, dimuons, and hypernuclei up to  $10^8$  Hz interaction rates. Further detailed design for accelerators and detectors are in progress. We have been also working on R&D of a triggerless DAQ system and a high resolution time-of-flight counter. The space for the spectrometer with two upgrade options will be prepared in the downstream of the high momentum beam line in the extended Hadron Experimental Facility at J-PARC. We would expect the earliest start of the experiment in 2025 or later, depending on the budget situation.

This work is supported by JSPS KAKENHI Grant Number 16K13808.

### References

- [1] H. Sako, et al, Letter-Of-Intent of J-PARC-HI, [https://j-parc.jp/researcher/Hadron/en/pac\\_1607/pdf/LoI\\_2016-16.pdf](https://j-parc.jp/researcher/Hadron/en/pac_1607/pdf/LoI_2016-16.pdf).
- [2] Y. Nara, et al, Phys. Rev. C **61**, 024901 (1999).
- [3] X. Luo, et al, Nucl. Phys. A **956** (2016) 75-82.
- [4] B. Friman, et al, Eur. Phys. J. C **71** (2011) 1694.
- [5] T. Hatsuda and R. S. Hayano, Rev. Mod. Phys. **82** (2005) 2949.
- [6] Table 13.2 (HSD model calculations) of FAIR Baseline Technical Report Volume 3b (2006).
- [7] M. C. Abreu, et al, Phys. Lett. B **477** 28-36 (2000).
- [8] B. P. Abbott, et al, Phys. Rev. Lett. **119** (2017) no.16, 161101.
- [9] Y. Nara, et al, Phys. Lett. B **769** 543-548 (2017).